

# M



SERIES



# SELECTION

Choose the model that best matches room conditions.

SELECT SERIES		
A multiple series line-up to choose from, each with various outstanding features. In addition to inverter-equipped models, constant-speed, floor-standing and cassette models can be selected. Choose the best series to match usage needs.		
Wall-mounted Units		
<b>MSZ-L SERIES</b> <b>R32</b> <b>R410A</b> *1  25/35/60 25/35 25/35 SEER A+++ SCOP A+++ MXZ connection	<b>MSZ-A SERIES</b> <b>R32</b> <b>R410A</b> *1 MSZ-AP60/71VG  MSZ-AP25-50VG MSZ-AP15-20VG 20/25/35 25-60 25/35 SEER A+++ SCOP A+++ MXZ connection	<b>MSZ-F SERIES</b> <b>R410A</b>  25/35 25/35 SEER A+++ SCOP A+++ MXZ connection
<b>MSZ-E SERIES</b> <b>R32</b> <b>R410A</b> *1  25/35 25/35 SEER A+++ SCOP A+++ MXZ connection	<b>MSZ-S SERIES</b> <b>R410A</b> MSZ-SF25-50VE  MSZ-SF15/20VA 20/25/35 25-60 SEER A+++ SCOP A+++ MXZ connection	<b>MSZ-G SERIES</b> <b>R410A</b>  25/35 25/35 SEER A+++ SCOP A+++ MXZ connection
<b>MSZ-BT SERIES</b> <b>R32</b> <b>R410A</b> *1  25/35 25/35 SEER A+++ SCOP A+++ MXZ connection	<b>MSZ-HR SERIES</b> <b>R32</b> MSZ-HR60/71VF  MSZ-HR25-50VF 20/25/35 25-60 SEER A+++ SCOP A+++ MXZ connection	<b>MSZ-W SERIES</b> <b>R410A</b>  25/35 25/35 SEER A+++ SCOP A+++ MXZ connection
<b>MSZ-D SERIES</b> <b>R410A</b>  25/35 25/35 SEER A+++ SCOP A+++ MXZ connection	<b>MSZ-H SERIES</b> <b>R410A</b> MSZ-HJ60/71  MSZ-HJ25/35/50 50/60/71 50/60/71 SEER A+++ SCOP A+++ MXZ connection	<b>MSY-TP SERIES</b> <b>R32</b>  35 SEER A+++ SCOP A+++ MXZ connection
Floor-standing	Cassette Units	
<b>MFZ SERIES</b> <b>R32</b>  25/35 25/35 SEER A+++ SCOP A+++ MXZ connection	<b>MLZ SERIES</b> <b>R32</b>  MXZ connection	SEER A SCOP A Energy Rank MXZ connection Compatible for connection to MXZ Series system R32 R32 Refrigerant R410A R410A Refrigerant *1 R410 is for multi connection.

SELECT OUTDOOR UNIT		
Some outdoor units in the line-up have heaters for use in cold regions. Units with an "H" in the model name are equipped with heaters.		
<b>Heater Installed</b> MUZ-AP25/35/42/50VGH MUZ-EF25/35VGH MUZ-SF25/35/42/50VEH  MUZ-LN25/35VG	<b>Hyper Heating</b> MUZ-LN25/35/50VGHZ MUZ-FH25/35/50VEHZ MUZ-KJ25/35/50VEHZ  MUZ-LN50VG	<b>Selecting a Heater-equipped Model</b> In regions with the following conditions, there is a possibility that water resulting from condensation on the outdoor unit when operating in the heating mode will freeze and not drain from the base. 1) Cold outdoor temperatures (temperature does not rise above 0°C all day) 2) Areas where dew forms easily (in the mountains, valleys (surrounded by mountains), near a forest, near unfrozen lakes, ponds, rivers or hot springs), or areas with snowfall. To prevent water from freezing in the base, it is recommended that a unit with a built-in heater be purchased. Please ask your dealer representative about the best model for you.

# MSZ-L SERIES

**R32**  
Single / Multi

**R410A**  
Multi

MSZ-LN18/25/35/50/60VG2



**GOOD DESIGN AWARD 2016**  
**BEST 100**



Developed to complement modern interior room décor, the LN Series is available in four colours specially chosen to blend in naturally wherever installed. Not only the sophisticated design, but also the optimum energy efficiency and operational comfort add even more value to this series.

## Luminous and Luxurious Design

Natural White, Pearl White, Ruby Red, and Onyx Black. LN Series indoor units are available in four colours to match various lifestyles. The appearance of the indoor unit differs depending on the lighting in the room, attracting the attention of everyone that enters the room.



Master craftsmanship painting technology has resulted in a refined design, giving the finish deep colour and a premium quality feel.

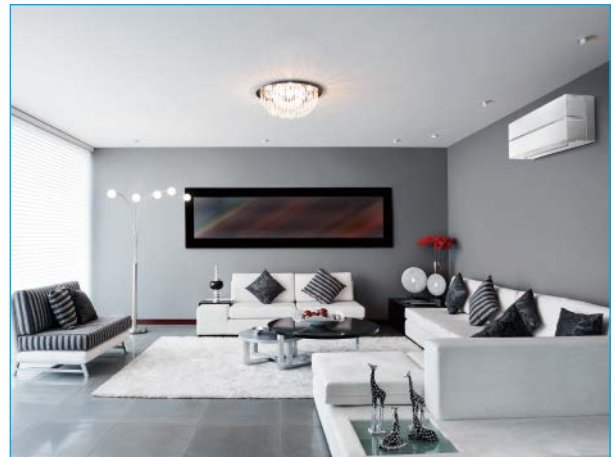

Pearl White blends in with any interior.

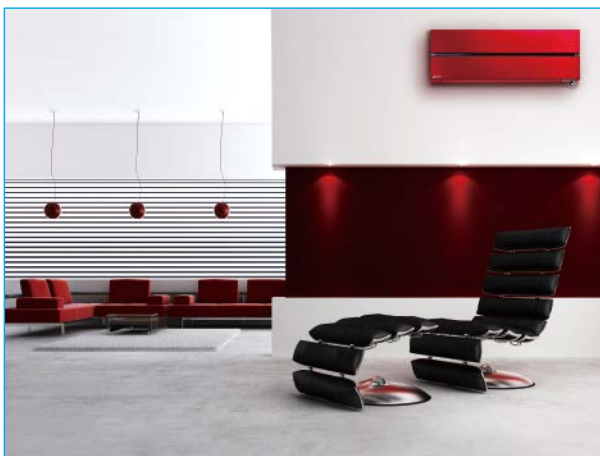

Ruby Red gives an accent to the room, affording timeless elegance to sophisticated interiors.



Onyx Black matches darker interiors, creating a comfortable environment.

## LED Backlight Remote Controller

Not only the indoor units, but the wireless remote controllers come in four colours as well. Each remote controller matches the indoor unit. Even the textures are the same.

The setting can be easily checked in the dark.



Pearl White



Ruby Red



Onyx Black



Natural White

## High Energy Efficiency



Optimum cooling/heating performance is another feature for the LN series. Models from capacities 25 to 50 have achieved the "Rank A+++" for SEER, and models for capacities 25 and 35 have achieved the "Rank A+++" for SCOP as well.

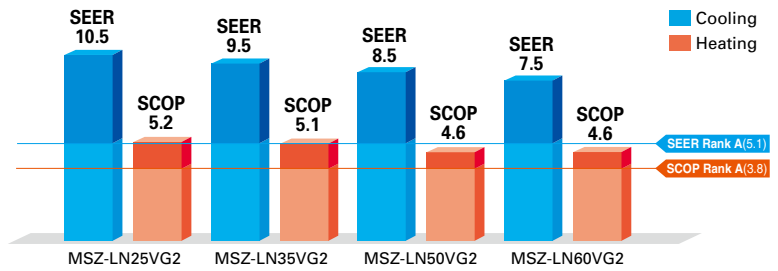

## 3D i-see Sensor

The LN Series is equipped with 3D i-see Sensor, an infrared-ray sensor that measures the temperature at distant positions. While moving to the left and right, eight vertically arranged sensor elements analyze the room temperature in three dimensions. This detailed analysis makes it possible to judge where people are in the room, thus allowing creation of features such as "Indirect airflow," to avoid airflow hitting people directly, and "direct airflow" to deliver airflow to where people are.

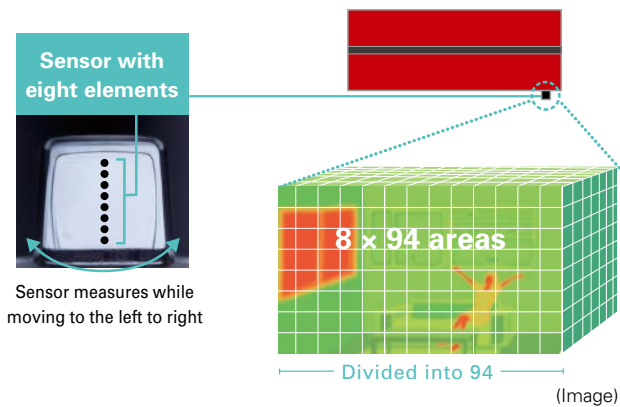

### Indirect Airflow

The indirect airflow setting can be used when the flow of air feels too strong or direct. For example, it can be used during cooling to avert airflow and prevent body temperature from becoming excessively cooled.

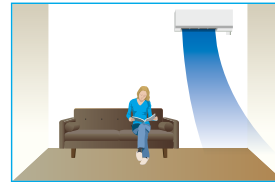

### Direct Airflow

This setting can be used to directly target airflow at people such as for immediate comfort when coming indoors on a hot (cold) day.

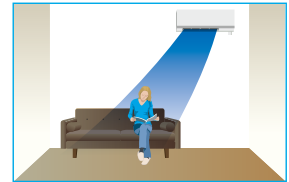

### Even Airflow \*LN Series only

Normal swing mode

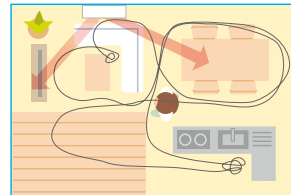

### Even airflow mode

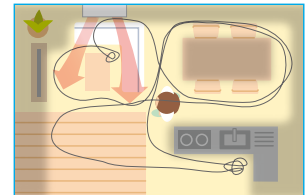

The airflow is distributed equally throughout the room, even to spaces where there is no human movement.

The 3D i-see sensor memorizes human movement and furniture positions, and efficiently distributes airflow.

### No occupancy energy-saving mode

The sensors detect whether there are people in the room. When no-one is in the room, the unit automatically switches to energy-saving mode.

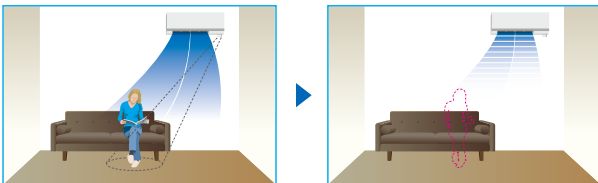

The "3D i-see Sensor" detects people's absence and the power consumption is automatically reduced approximately 10% after 10 minutes and 20% after 60 minutes.

### No occupancy Auto-OFF mode \*LN Series only

The sensors detect whether or not there are people in the room. When there is no one in the room, the unit turns off automatically.

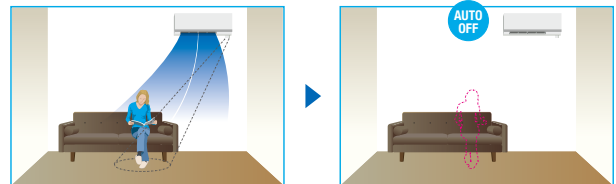

## Circulator Operation

In case the indoor temperature reaches the setting temperature, the outdoor unit stops and the indoor unit starts FAN operation to circulate the indoor air.

The outdoor unit starts operation automatically when the indoor temperature drops below the setting temperature.

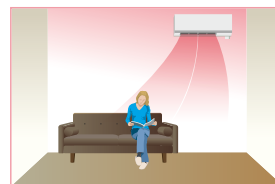

If the heating operation is continued, the warm air is formed around ceiling.

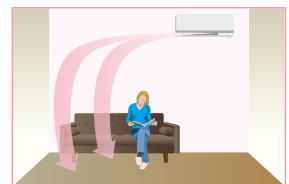

This operating can help to circulate and rene warm air.

# Plasma Quad Plus

Plasma Quad Plus is a plasma-based filter system that effectively removes six kinds of air pollutants. Plasma Quad Plus captures mold and allergens more effectively than Plasma Quad. It can also capture PM2.5 and particles smaller than 2.5µm, creating healthy living spaces for all.

**Bacteria**

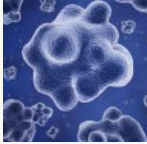

Test results have confirmed that Plasma Quad Plus neutralizes 99% of bacteria in 162 minutes in a 25m<sup>3</sup> test space.

<Test No.> KRCEs-Bio. Test Report No. 2016-0118

**Viruses**



Test results have confirmed that Plasma Quad Plus neutralizes 99% of virus particles in 72 minutes in a 25m<sup>3</sup> test space.

<Test No.> vrc.center, SMC No. 28-002

**Molds**

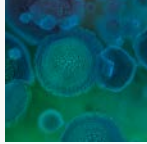

Test results have confirmed that Plasma Quad Plus neutralizes 99% of mold in 135 minutes in a 25m<sup>3</sup> test space.

<Test No.> Japan Food Research Laboratories Test Report No. 16069353001-0201

**Allergens**



In a test, air containing cat fur and pollen was passed through the air cleaning device at the low airflow setting. Before and after measurements confirm that Plasma Quad Plus neutralizes 98% of cat fur and pollen.

<Test No.> ITEA Report No. T1606028

**PM2.5**



Test results have confirmed that Plasma Quad Plus removes 99% of PM2.5 in 145 minutes in a 28m<sup>3</sup> test space.

<In-company investigation>

**Dust**



Test results have confirmed that Plasma Quad Plus removes 99.7% of dust and mites.

<Test No.> ITEA Report No. T1606028

Model	Name	Method	Bacteria	Viruses	Molds	Allergens	Dust	PM2.5*
FH Series	Plasma Quad	One-Stage Plasma	A	A	B	B	C	
LN Series	Plasma Quad Plus	Two-Stage Plasma	A	A	A	A	A	A

A: Highly effective  
B: Effective  
C: Partially effective

\*PM2.5:  
Particles smaller than 2.5µm



## Image of Plasma Quad Plus

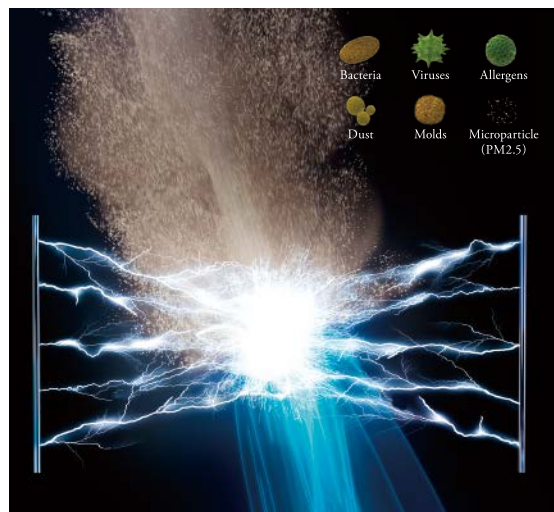

**Principle of Plasma Quad Plus**

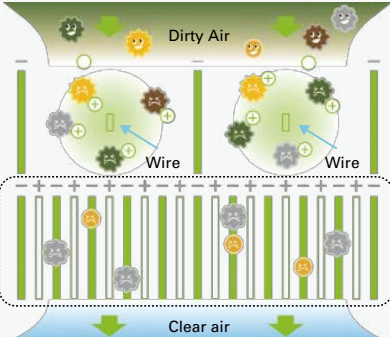

**1st stage**

- Make plasma.
- Break mold and allergens.
- Inhibit viruses.
- Dust and PM2.5 given an electrical charge (+).

**2nd stage**

- Make a strong electrical field.
- The charged dust and PM2.5 (+) are absorbed in the strong electrical field (-).

Legend: Dust, PM2.5 (grey circle); Viruses (yellow star); Bacteria (green circle); Mold (orange circle); Allergens (yellow smiley face).





# Dual Barrier Coating

A two-barrier coating prevents dust and greasy dirt from getting into the air conditioner.

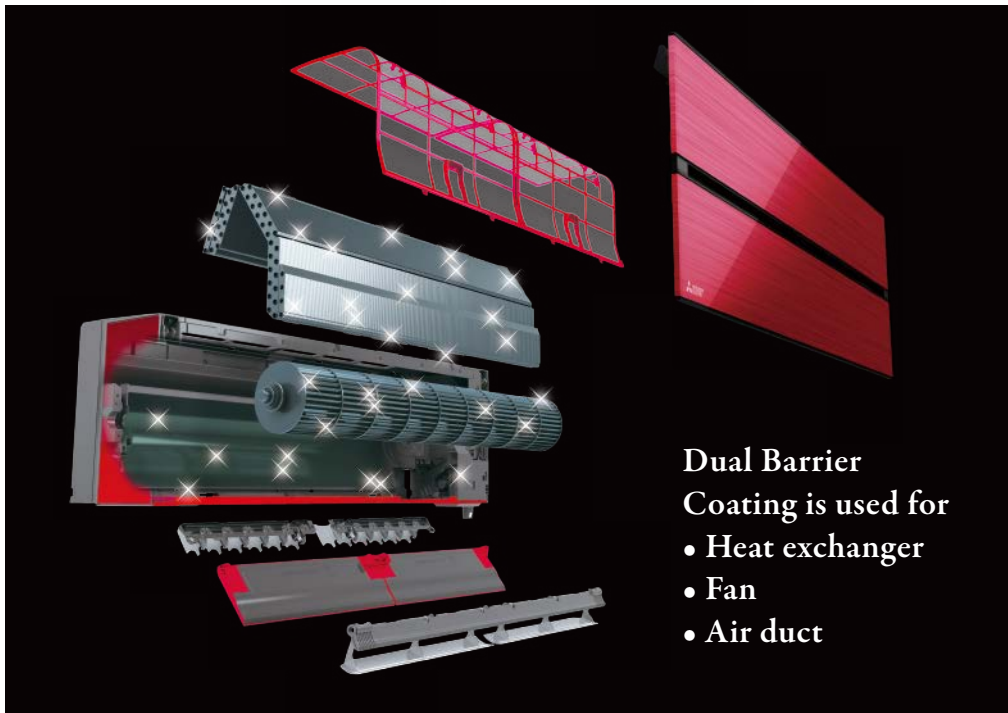

## State-of-the-art coating technology

Dirt is generally classified into two groups: hydrophilic dirt such as fiber dust and sand dust, and hydrophobic dirt such as oil and cigarette smoke. Mitsubishi Electric's dual barrier coating works as a two-barrier coating with blended "fluorine particles" that prevent hydrophilic dirt penetration and "hydrophilic particles" that prevent hydrophobic dirt from getting into the air conditioner. This dual coating on the inner surface keeps the air conditioner clean year-round.

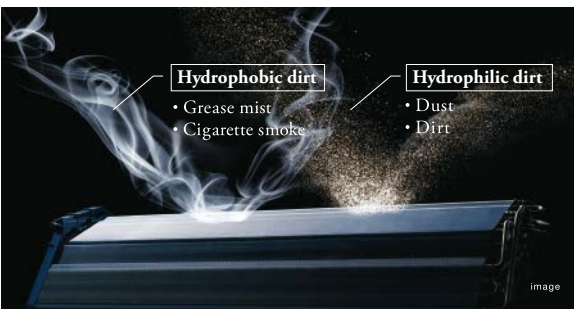

### Comparison of dirt on heat exchanger, fan and air duct (in-house comparison)

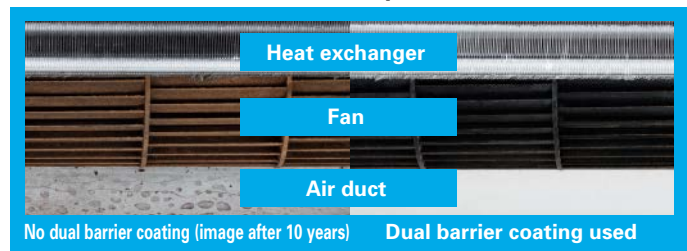

### The inside of the indoor unit gets dirty after many years of usage.

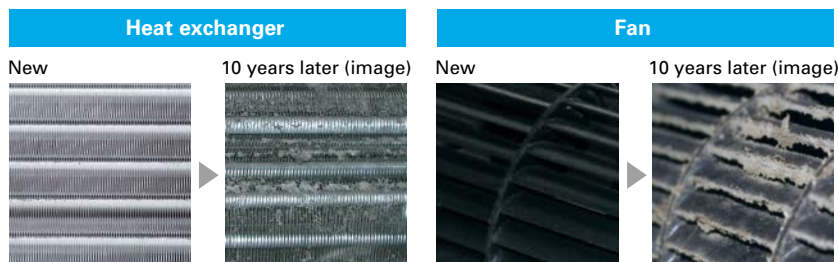

#### Consequences when the inside of the indoor unit is left dirty.

- Deterioration in energy efficiency.
- Musty smell from the unit.

## Double Flap

The vanes create various airflows to make each person in the room comfortable. Not only the horizontal vanes, but also the vertical vanes move independently, eliminating hot spots or cold spots throughout the room.



## Night Mode

When Night Mode is activated using the wireless remote controller, air conditioner operation will switch to the following settings.

- The brightness of the operation indicator lamp will become dimmer.
- The beeping sound will be disabled.
- The outdoor operating noise will drop to 3dB lower than the rated operating noise specification.

\*The cooling/heating capacity may drop.

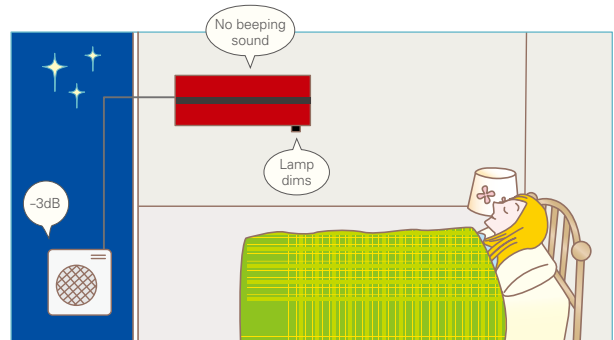

## 10°C Heating

During heating operation, the temperature can be set in 1°C increments down to 10°C.

This function can also be used with the Weekly Timer setting.

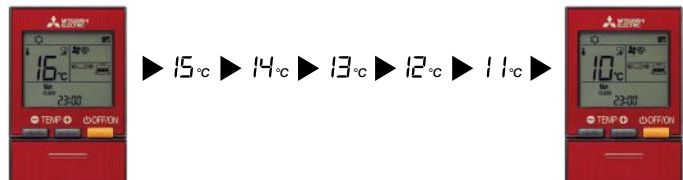

## Quiet Operation

The indoor unit noise level is as low as 19dB for LN25/35 models, offering a peaceful inside environment.

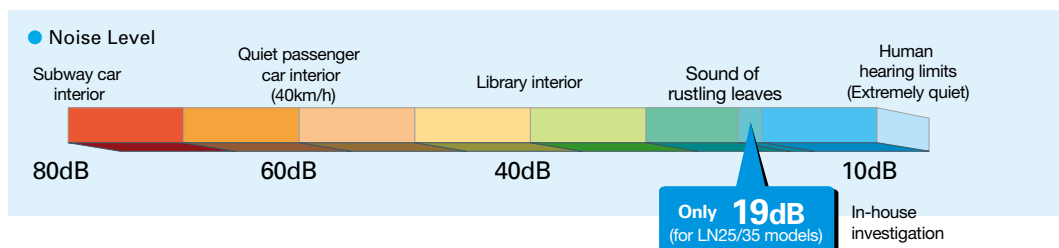

## Built-in Wi-Fi Interface

The indoor unit is equipped with a Wi-Fi Interface inside an exclusive pocket in the unit.

This eliminates the need to install a Wi-Fi interface, and also contributes to the beautiful appearance since the interface is hidden.

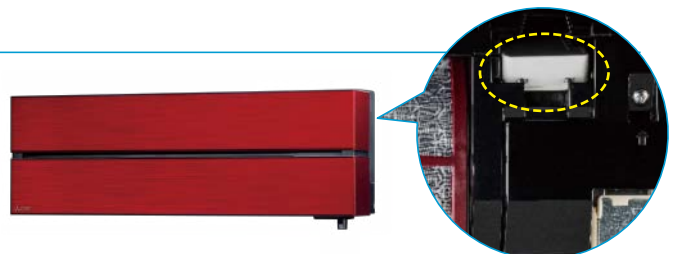

# MSZ-L SERIES



## Indoor Unit / Remote Controller

R32 R410A



## Outdoor Unit R32

<Pearl White>



MSZ-LN18/25/35/50/60VG2V

<Ruby Red>



MSZ-LN18/25/35/50/60VG2R

<Natural White>



MSZ-LN18/25/35/50/60VG2W

<Onyx Black>



MSZ-LN18/25/35/50/60VG2B



MUZ-LN25/35VG2



MUZ-LN50VG2



MUZ-LN60VG



Type	Inverter Heat Pump							
Indoor Unit	MSZ-LN18VG2	MSZ-LN25VG2	MSZ-LN35VG2	MSZ-LN50VG2	MSZ-LN60VG2			
Outdoor Unit	for MXZ connection	MUZ-LN25VG2	MUZ-LN35VG2	MUZ-LN50VG2	MUZ-LN60VG			
Refrigerant	Single: R32 <sup>(1)</sup> / Multi: R410A or R32 <sup>(1)</sup>							
Power Source	Outdoor Power Supply							
Supply	Outdoor (V / Phase / Hz)							
			230 / Single / 50					
Cooling	Design load	kW	–	2.5	3.5	5.0	6.1	
	Annual electricity consumption <sup>(2)</sup>	kWh/a	–	83	129	205	285	
	SEER <sup>(4)</sup>		–	10.5	9.5	8.5	7.5	
	Energy efficiency class			–	A+++	A+++	A+++	A++
		Capacity						
Heating (Average Season) <sup>(3)</sup>	Design load	kW	–	3.0 (-10°C)	3.6 (-10°C)	4.5 (-10°C)	6.0 (-10°C)	
	Declared Capacity	at reference design temperature	kW	–	3.0 (-10°C)	3.6 (-10°C)	4.5 (-10°C)	6.0 (-10°C)
		at bivalent temperature	kW	–	3.0 (-10°C)	3.6 (-10°C)	4.5 (-10°C)	6.0 (-10°C)
	at operation limit temperature	kW	–	2.5 (-15°C)	3.2 (-15°C)	4.2 (-15°C)	6.0 (-15°C)	
	Back up heating capacity	kW	–	0.0 (-10°C)	0.0 (-10°C)	0.0 (-10°C)	0.0 (-10°C)	
Annual electricity consumption <sup>(2)</sup>	kWh/a	–	807	987	1369	1826		
SCOP <sup>(4)</sup>		–	5.2	5.1	4.6	4.6		
Operating Current (Max)	Energy efficiency class		–	A+++	A+++	A++	A++	
		Capacity						
	Rated	kW	–	3.2	4.0	6.0	6.8	
	Min-Max	kW	–	0.7 - 5.4	0.9 - 6.3	1.0 - 8.2	1.8 - 9.3	
	Total Input	kW	–	0.600	0.820	1.480	1.810	
Indoor Unit	Input	Rated	A	–	7.1	9.9	13.9	15.2
		Rated	kW	0.027	0.027	0.027	0.034	0.040
	Operating Current(Max)	A	0.3	0.3	0.3	0.4	0.4	
	Dimensions	H*W*D	mm	307-890-233	307-890-233	307-890-233	307-890-233	307-890-233
		Weight	kg	14.5 (W) 15.5 (V, R, B)	14.5 (W) 15.5 (V, R, B)	14.5 (W) 15.5 (V, R, B)	15 (W) 16 (V, R, B)	15 (W) 16 (V, R, B)
Outdoor Unit	Air Volume	Cooling	m <sup>3</sup> /min	4.7 - 5.9 - 7.1 - 9.2 - 12.4	4.7 - 5.9 - 7.1 - 9.2 - 12.4	4.7 - 5.9 - 7.1 - 9.2 - 13.0	5.7 - 7.6 - 8.8 - 10.6 - 13.9	7.1 - 8.8 - 10.6 - 12.7 - 15.7
		Heating	m <sup>3</sup> /min	4.5 - 6.6 - 7.5 - 11.0 - 13.9	4.5 - 6.6 - 7.5 - 11.0 - 13.9	4.5 - 6.6 - 7.5 - 11.0 - 13.9	5.4 - 6.4 - 8.5 - 10.7 - 15.7	6.6 - 9.5 - 11.5 - 13.6 - 15.7
	Sound Level (SPL)	Cooling	dB(A)	19 - 23 - 29 - 36 - 42	19 - 23 - 29 - 36 - 42	19 - 24 - 29 - 36 - 43	27 - 31 - 35 - 39 - 46	29 - 37 - 41 - 45 - 49
		Heating	dB(A)	19 - 24 - 29 - 38 - 45	19 - 24 - 29 - 38 - 45	19 - 24 - 29 - 38 - 45	25 - 29 - 34 - 39 - 47	29 - 37 - 41 - 45 - 49
	Sound Level (PWL)	Cooling	dB(A)	58	58	59	64	65
Ext. Piping	Dimensions	H*W*D	mm	–	550-800-285	550-800-285	714-800-285	880-840-330
		Weight	kg	–	33	34	40	55
	Air Volume	Cooling	m <sup>3</sup> /min	–	34.3	34.3	40.0	50.1
		Heating	m <sup>3</sup> /min	–	32.7	32.7	40.5	51.3
	Sound Level (SPL)	Cooling	dB(A)	–	46	49	51	55
Heating		dB(A)	–	49	50	54	55	
Guaranteed Operating Range (Outdoor)	Sound Level (PWL)	Cooling	dB(A)	–	60	61	64	65
		Heating	dB(A)	–	60	61	64	65
	Operating Current (Max)	A	–	6.8	9.6	13.5	14.8	
		Breaker Size	A	–	10	10	16	16
	Diameter	Liquid/Gas	mm	–	6.35/9.52	6.35/9.52	6.35/9.52	6.35/12.7
Max.Length	Out-In	m	–	20	20	30	30	
	Max.Height	m	–	12	12	15	15	
Guaranteed Operating Range (Outdoor)	Cooling	°C	–	-10 ~ +46	-10 ~ +46	-10 ~ +46	-10 ~ +46	
	Heating	°C	–	-15 ~ +24	-15 ~ +24	-15 ~ +24	-15 ~ +24	

(1) Refrigerant leakage contributes to climate change. Refrigerant with lower global warming potential (GWP) would contribute less to global warming than a refrigerant with higher GWP, if leaked to the atmosphere. This appliance contains a refrigerant fluid with a GWP equal to 550. This means that if 1 kg of this refrigerant fluid would be leaked to the atmosphere, the impact on global warming would be 550 times higher than 1 kg of CO<sub>2</sub> over a period of 100 years. Never try to interfere with the refrigerant circuit yourself or disassemble the product yourself and always ask a professional.

The GWP of R32 is 675 in the IPCC 4th Assessment Report.

(2) Energy consumption based on standard test results. Actual energy consumption will depend on how the appliance is used and where it is located.

(3) SHi: Super High

(4) SEER, SCOP and other related description are based on COMMISSION DELEGATED REGULATION (EU) No.626/2011. The temperature conditions for calculating SCOP are based on "Average Season".

(5) Please see page 51-52 for heating (warmer season) specifications.



# MSZ-A SERIES

Introducing a compact and stylish indoor unit with various capacity, designed to match number of rooms. High performance indoor and outdoor units enabled to achieve "Rank A+++" for SEER. \*MSZ-AP20/25/35VG



MSZ-AP15/20VG



MSZ-AP25/35/42/50VG



MSZ-AP60/71VG



## High energy saving



All models in the series, from the low-capacity 25 to the high-capacity 60, have achieved either the "Rank A+++" or "Rank A++" for SEER and SCOP as energy-savings rating. Our air conditioners are contributing to reduce energy consumption in a wide range.

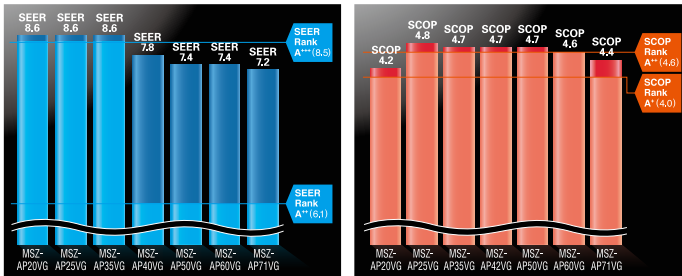

## Compact and stylish

15 class are for multi-systems and 25-71 class are introduced as single-split and multi-systems. From small rooms to living rooms, it is possible to coordinate residences with a unified design.

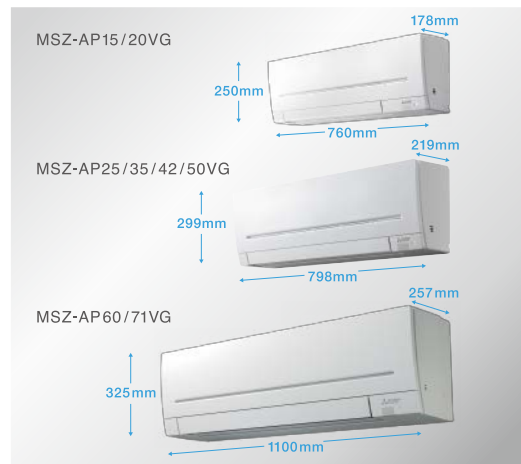

## Evolved comfortable convenience function

### Horizontal Airflow

### Auto Vane Control

### The Function

- Econo Cool
- AUTO VANE
- Air Purifying
- SWING
- SWING
- AUTO
- Weekly Timer
- i save
- ACO
- Auto Restart
- Low Temp Cooling
- Optional
- Group Control
- M-NET connection
- Optional
- Optional
- Optional
- Wi-Fi Interface
- MXZ connection
- 10°C
- Night
- Built-in\*\* / optional
- Flare connection
- Self Diagnosis
- Failure Recall

The new airflow control which spreads across the ceiling eliminates the uncomfortable drafty feeling.

Auto vanes can be moved left and right, and up and down using the remote controller.\*

\*Only for 25/35/42/50/60/71 models.  
\*\*Only for 20/25/35/42/50/60/71 models.

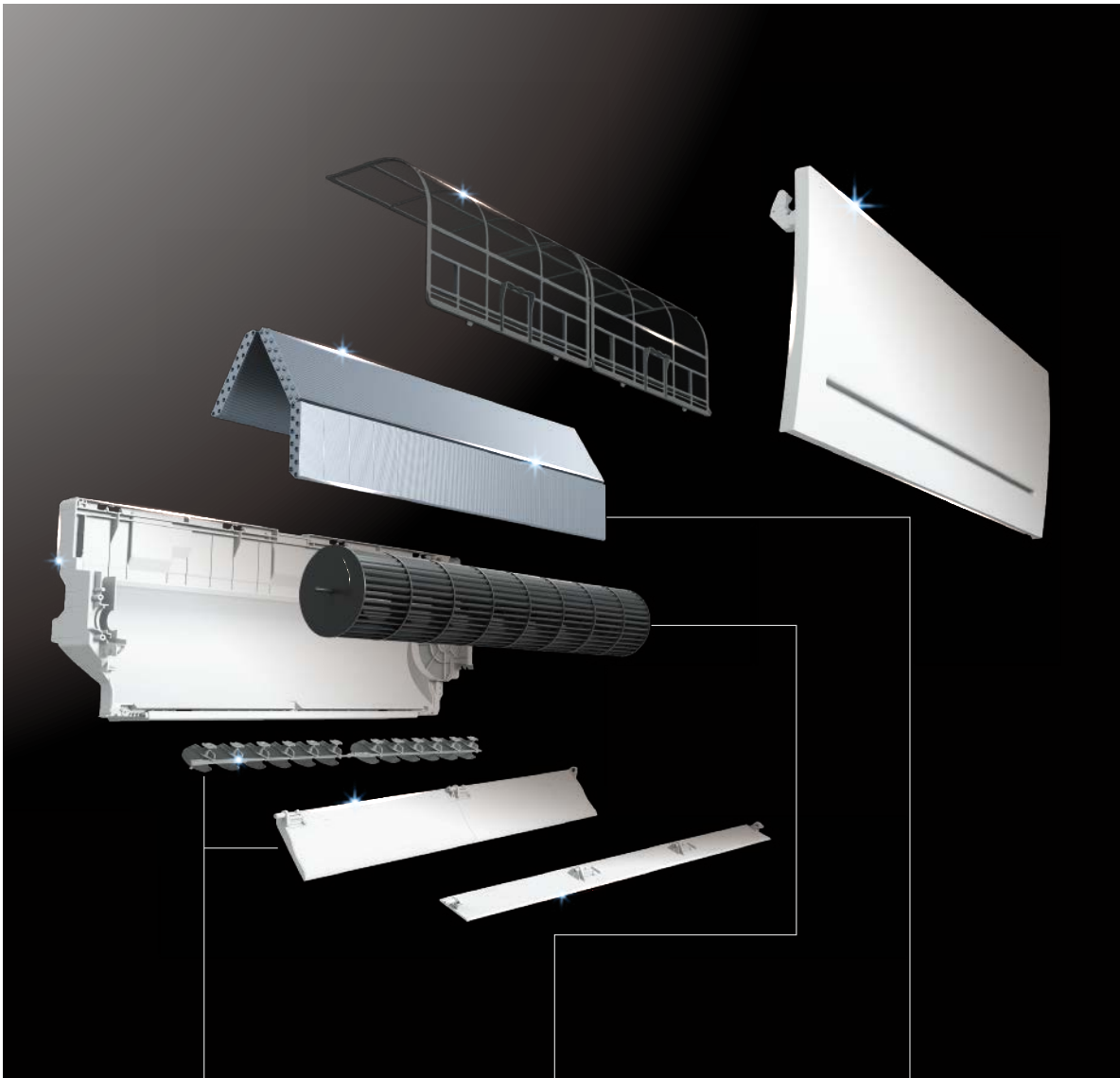

Comfort

### Vertical and Horizontal Vane

New vertical and horizontal vanes are double the size of the previous model, improving airflow control elaborately.

175% larger  
204% larger

High Performance

### Line Flow Fan

New line flow Fan is 122% larger and 108% wider than the previous model, leading to higher aerodynamic performance. Also, same sound level as the previous model.

122% larger  
108% larger

High Performance

### Heat Exchanger

New ø5 Heat exchanger enables to realise 32% thinner depth than the previous model. It realises low pressure loss leading to high performance.

32% Thinner

## “Weekly Timer”

Weekly Timer

Easily set desired temperatures and operation start/stop times to match lifestyle patterns. Reduce wasted energy consumption by using the timer to prevent forgetting to turn off the unit and eliminate temperature setting adjustments.

### ■ Example Operation Pattern (Winter/Heating mode)

	Mon.	Tues.	Wed.	Thurs.	Fri.	Sat.	Sun.
6:00	ON 20°C	ON 20°C	ON 20°C	ON 20°C	ON 20°C	ON 20°C	ON 20°C
8:00	Automatically changes to high-power operation at wake-up time						
10:00	OFF	OFF	OFF	OFF	OFF	ON 18°C	ON 18°C
12:00	Automatically turned off during work hours					Midday is warmer, so the temperature is set lower	
14:00							
16:00							
18:00	ON 20°C	ON 20°C	ON 20°C	ON 20°C	ON 20°C	ON 20°C	ON 20°C
20:00	Automatically turns on, synchronized with arrival at home					Automatically raises temperature setting to match time when outside-air temperature is low	
22:00							
(during sleeping hours)	ON 18°C	ON 18°C	ON 18°C	ON 18°C	ON 18°C	ON 18°C	ON 18°C
	Automatically lowers temperature at bedtime for energy-saving operation at night						

#### Settings

**Pattern Settings:** Input up to four settings for each day

**Settings:** •Start/Stop operation •Temperature setting \*The operation mode cannot be set.

### ■ Easy set-up using dedicated buttons



The remote controller is equipped with buttons that are used exclusively for setting the Weekly Timer. Setting operation patterns is easy and quick.



#### How to set the Weekly Timer

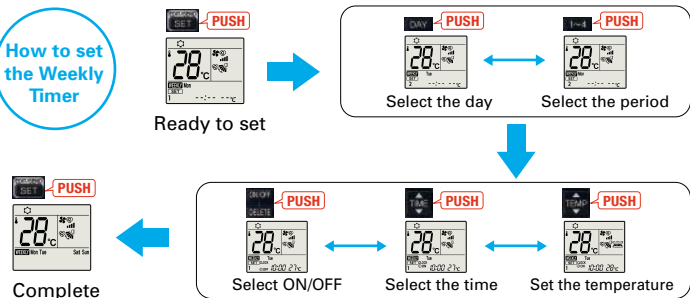

- Start by pushing the “SET” button and follow the instructions to set the desired patterns. Once all of the desired patterns are input, point the top end of the remote controller at the indoor unit and push the “SET” button one more time. (Push the “SET” button only after inputting all of the desired patterns into the remote controller memory. Pushing the “CANCEL” button will end the set-up process without sending the operation patterns to the indoor unit).
- It takes a few seconds to transmit the Weekly Timer operation patterns to the indoor unit. Please continue to point the remote controller at the indoor unit until all data has been sent.
- When “Weekly Timer” is set, temperature can not be set 10°C. (only for 15/20 models)

## Low Standby Power

Electrical devices consume standby power even when they are not in actual use. While we obviously strive to reduce power consumption during actual use, reducing this wasted power that cannot be seen is also very important.

without  
“Low standby power”

around 10W

with  
“Low standby power”

below 1W

around 90% reduction

## Air Purifying Filter

(MSZ-AP25/35/42/50/60/71)

Air Purifying

This filter generates stable antibacterial and deodourising effects. The size of the three-dimensional surface has been increased as well, enlarging the filter capture area. These features give the Air Purifying Filter better dust collection performance than conventional filters. The superior air-cleaning effectiveness raises room comfort yet another level.

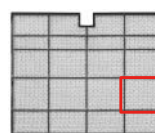

\* It is okay to wash the filter with water (air-cleaning effect is maintained)

3D surface (Waved surface)

## “i save” Mode



“i save” is a simplified setting function that recalls the preferred (preset) temperature by pressing a single button on the remote controller. Press the same button twice in repetition to immediately return to the previous temperature setting. Using this function contributes to comfortable, waste-free operation, realising the most suitable air conditioning settings and saving on power consumption when, for example, leaving the room or going to bed.

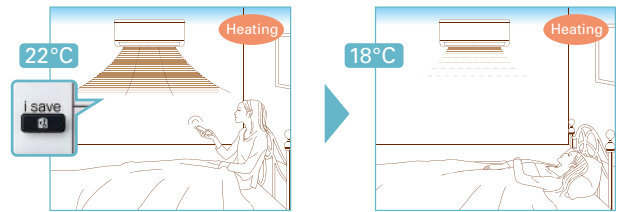

\* Temperature can be preset to 10°C when heating in the “i-save” mode. (only for 15/20 models)

## Outdoor Units for Cold Region

(MSZ-AP25/35/42/50)

Single split-type outdoor units are available in both standard and heater-equipped units. An electric heater is installed in each unit to prevent freezing in cold outdoor environments.

Standard Units

Heater Installed



## Night Mode

(MSZ-AP20/25/35/42/50/60/71)



When Night Mode is activated using the wireless remote controller, air conditioner operation will switch to the following settings.

- The brightness of the operation indicator lamp will become dimmer.
- The beeping sound will be disabled.
- The outdoor operating noise will drop to 3dB lower than the rated operating noise specification.

\*The cooling/heating capacity may drop.

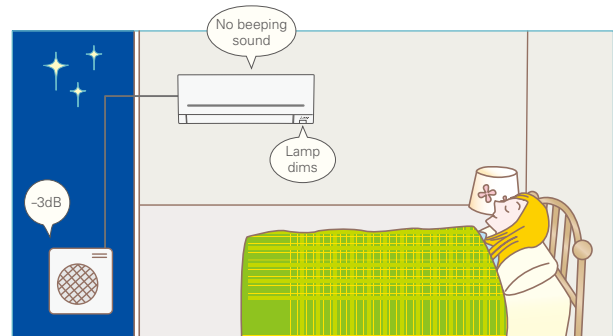

## Quiet Operation

The indoor unit noise level is as low as 19dB for AP Series, offering a peaceful inside environment.

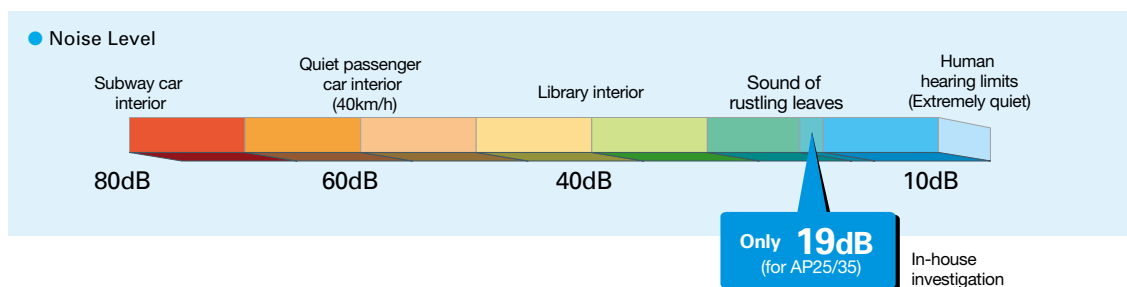

## Built-in Wi-Fi Interface

(MSZ-AP25/35/42/50/60/71VGK)



The indoor unit is equipped with a Wi-Fi Interface inside an exclusive pocket in the unit. This eliminates the need to install a Wi-Fi interface, and also contributes to the beautiful appearance since the interface is hidden.

# MSZ-A SERIES

Indoor Unit

R32 R410A



MSZ-AP15/20VG



\*AP15 for MXZ Connection Only

Outdoor Unit

R32



MUZ-AP20VG

Remote Controller



Type	Inverter Heat Pump								
Indoor Unit	MSZ-AP15VG	MSZ-AP20VG	MSZ-AP25VG(K)	MSZ-AP25VG(K)	MSZ-AP35VG(K)	MSZ-AP35VG(K)			
Outdoor Unit	for MXZ connection	MUZ-AP20VG	MUZ-AP25VG	MUZ-AP25VGH	MUZ-AP35VG	MUZ-AP35VGH			
Refrigerant	Single: R32 <sup>(1)</sup> / Multi: R410A or R32 <sup>(1)</sup>								
Power Supply	Outdoor Power supply								
Source	230 / Single / 50								
Cooling	Design load	kW	-	2.0	2.5	2.5	3.5	3.5	
	Annual electricity consumption <sup>(2)</sup>	kWh/a	-	81	101	101	142	142	
	SEER <sup>(4)</sup>	-	-	8.6	8.6	8.6	8.6	8.6	
	Capacity	Energy efficiency class		-	A+++	A+++	A+++	A+++	A+++
		Rated	kW	-	2.0	2.5	2.5	3.5	3.5
Heating (Average Season) <sup>(5)</sup>	Declared Capacity	kW	-	2.3 (-10°C)	2.4 (-10°C)	2.4 (-10°C)	2.9 (-10°C)	2.9 (-10°C)	
	Back up heating capacity	at reference design temperature	kW	-	2.3 (-10°C)	2.4 (-10°C)	2.4 (-10°C)	2.9 (-10°C)	2.9 (-10°C)
		at bivalent temperature	kW	-	2.3 (-10°C)	2.4 (-10°C)	2.4 (-10°C)	2.9 (-10°C)	2.9 (-10°C)
		at operation limit temperature	kW	-	2.2 (-15°C)	2.4 (-15°C)	2.2 (-20°C)	2.6 (-15°C)	2.4 (-20°C)
	Annual electricity consumption <sup>(2)</sup>	kWh/a	-	0.0 (-10°C)	0.0 (-10°C)	0.0 (-10°C)	0.0 (-10°C)	0.0 (-10°C)	
Indoor Unit	Operating Current (Max)	A	-	7.0	7.1	7.1	8.5	8.5	
		Input	Rated	kW	0.017	0.019	0.026	0.026	0.026
	Dimensions	H*W*D	mm	250-760-178	250-760-178	299-798-219	299-798-219	299-798-219	299-798-219
		Weight	kg	8.2	8.2	10.5	10.5	10.5	10.5
	Outdoor Unit	Air Volume (SLo-Lo-Mid-Hi-SH <sup>(3)</sup> Dry/Wet)	Cooling	m <sup>3</sup> /min	3.5 - 3.9 - 4.6 - 5.5 - 6.4	3.5 - 3.9 - 4.6 - 5.5 - 6.9	4.9 - 5.9 - 7.1 - 8.7 - 11.4	4.9 - 5.9 - 7.1 - 8.7 - 11.4	4.9 - 5.9 - 7.1 - 8.7 - 11.4
Heating			m <sup>3</sup> /min	3.7 - 4.4 - 5.0 - 6.0 - 6.8	3.7 - 4.4 - 5.0 - 6.0 - 7.3	4.9 - 5.9 - 7.3 - 8.9 - 12.9	4.9 - 5.9 - 7.3 - 8.9 - 12.9	4.9 - 5.9 - 7.3 - 8.9 - 12.9	4.9 - 5.9 - 7.3 - 8.9 - 12.9
Sound Level (SPL)		Cooling	dB(A)	21 - 26 - 30 - 35 - 40	21 - 26 - 30 - 35 - 42	19 - 24 - 30 - 36 - 42	19 - 24 - 30 - 36 - 42	19 - 24 - 30 - 36 - 42	19 - 24 - 30 - 36 - 42
		Heating	dB(A)	21 - 26 - 30 - 35 - 40	21 - 26 - 30 - 35 - 42	19 - 24 - 34 - 39 - 45	19 - 24 - 34 - 39 - 45	19 - 24 - 31 - 38 - 45	19 - 24 - 31 - 38 - 45
Ext. Piping		Sound Level (PWL)	Cooling	dB(A)	59	60	57	57	57
	Heating		dB(A)	59	59	59	61	61	
	Operating Current (Max)	A	-	6.8	6.8	6.8	8.2	8.2	
		Breaker Size	A	-	10	10	10	10	10
	Diameter	Liquid/Gas	mm	6.35 / 9.52	6.35 / 9.52	6.35 / 9.52	6.35 / 9.52	6.35 / 9.52	
Max.Length	Out-In	m	-	20	20	20	20	20	
	Out-In	m	-	12	12	12	12	12	
	Max.Height	m	-	12	12	12	12	12	
Guaranteed Operating Range (Outdoor)	Cooling	°C	-	-10 ~ +46	-10 ~ +46	-10 ~ +46	-10 ~ +46	-10 ~ +46	
	Heating	°C	-	-15 ~ +24	-15 ~ +24	-20 ~ +24	-15 ~ +24	-20 ~ +24	

(1) Refrigerant leakage contributes to climate change. Refrigerant with lower global warming potential (GWP) would contribute less to global warming than a refrigerant with higher GWP, if leaked to the atmosphere. This appliance contains a refrigerant fluid with a GWP equal to 550. This means that if 1 kg of this refrigerant fluid would be leaked to the atmosphere, the impact on global warming would be 550 times higher than 1 kg of CO<sub>2</sub> over a period of 100 years. Never try to interfere with the refrigerant circuit yourself or disassemble the product yourself and always ask a professional.  
The GWP of R32 is 675 in the IPCC 4th Assessment Report.

(2) Energy consumption based on standard test results. Actual energy consumption will depend on how the appliance is used and where it is located.

(3) SH: Super High

(4) SEER, SCOP and other related description are based on COMMISSION DELEGATED REGULATION (EU) No.626/2011. The temperature conditions for calculating SCOP are based on "Average Season".

(5) Please see page 51-52 for heating (warmer season) specifications.



# MSZ-A SERIES



## Indoor Unit

**R32 R410A**

※VGK model Wi-Fi Interface built-in.



MSZ-AP25/35/42/50VG(K)



MSZ-AP60/71VG(K)

## Outdoor Unit

**R32**



MUZ-AP25/35/42VG(H)



MUZ-AP50VG(H)/60VG



MUZ-AP71VG

## Remote Controller



Type	Inverter Heat Pump								
Indoor Unit	MSZ-AP42VG(K)	MSZ-AP42VG(K)	MSZ-AP50VG(K)	MSZ-AP50VG(K)	MSZ-AP60VG(K)	MSZ-AP71VG(K)			
Outdoor Unit	MUZ-AP42VG	MUZ-AP42VGH	MUZ-AP50VG	MUZ-AP50VGH	MUZ-AP60VG	MUZ-AP71VG			
Refrigerant	Single: R32 <sup>(1)</sup> / Multi: R410A or R32 <sup>(1)</sup>				Single: R32 <sup>(1)</sup>				
Power Supply	Outdoor Power supply								
	230 / Single / 50								
Cooling	Design load	kW	4.2	4.2	5.0	5.0	6.1	7.1	
	Annual electricity consumption <sup>(2)</sup>	kWh/a	188	188	236	236	288	345	
	SEER <sup>(4)</sup>		7.8	7.8	7.4	7.4	7.4	7.2	
	Energy efficiency class	Rated		A++	A++	A++	A++	A++	A++
		Capacity	kW	4.2	4.2	5.0	5.0	6.1	7.1
	Min-Max	kW	0.9-4.5	0.9-4.5	1.4-5.4	1.4-5.4	1.4-7.3	2.0-8.7	
	Total Input	Rated	kW	1.300	1.300	1.550	1.550	1.590	2.010
Heating (Average Season) <sup>(5)</sup>	Design load	kW	3.8 (-10°C)	3.8 (-10°C)	4.2 (-10°C)	4.2 (-10°C)	4.6 (-10°C)	6.7 (-10°C)	
	Declared Capacity	at reference design temperature	kW	3.8 (-10°C)	3.8 (-10°C)	4.2 (-10°C)	4.2 (-10°C)	4.6 (-10°C)	6.7 (-10°C)
		at bivalent temperature	kW	3.8 (-10°C)	3.8 (-10°C)	4.2 (-10°C)	4.2 (-10°C)	4.6 (-10°C)	6.7 (-10°C)
		at operation limit temperature	kW	4.2 (-15°C)	3.8 (-20°C)	4.7 (-15°C)	4.2 (-20°C)	3.7 (-15°C)	5.4 (-15°C)
	Back up heating capacity	kW	0.0 (-10°C)	0.0 (-10°C)	0.0 (-10°C)	0.0 (-10°C)	0.0 (-10°C)	0.0 (-10°C)	
	Annual electricity consumption <sup>(2)</sup>	kWh/a	1120	1134	1250	1275	1398	2132	
	SCOP <sup>(4)</sup>		4.7	4.6	4.7	4.6	4.6	4.4	
Energy efficiency class	Rated		A++	A++	A++	A++	A+		
	Capacity	kW	5.4	5.4	5.8	5.8	6.8	8.1	
Min-Max	kW	1.3-6.0	1.3-6.0	1.4-7.3	1.4-7.3	2.0-8.6	2.2-10.3		
Total Input	Rated	kW	1.490	1.490	1.600	1.600	1.670	2.120	
Operating Current (Max)		A	9.9	9.9	13.6	13.6	14.1	16.4	
Indoor Unit	Input	Rated	kW	0.032	0.032	0.032	0.032	0.049	0.045
		Operating Current (Max)	A	0.3	0.3	0.3	0.3	0.5	0.4
	Dimensions	H*W*D	mm	299-798-219	299-798-219	299-798-219	299-798-219	325-1100-257	325-1100-257
	Weight	kg	10.5	10.5	10.5	10.5	16.0	17.0	
	Air Volume (SLo-Lo-Mid-Hi-SH <sup>(3)</sup> Dry/Wet)	Cooling	m <sup>3</sup> /min	5.4 - 6.5 - 7.7 - 9.3 - 11.4	5.4 - 6.5 - 7.7 - 9.3 - 11.4	6.0 - 7.2 - 8.4 - 10.0 - 12.6	6.0 - 7.2 - 8.4 - 10.0 - 12.6	9.4 - 11.0 - 13.2 - 16.0 - 18.9	9.6 - 11.5 - 13.2 - 15.3 - 18.6
		Heating	m <sup>3</sup> /min	5.3 - 6.1 - 7.7 - 9.4 - 14.0	5.3 - 6.1 - 7.7 - 9.4 - 14.0	5.6 - 6.5 - 8.2 - 10.0 - 14.0	5.6 - 6.5 - 8.2 - 10.0 - 14.0	10.8 - 13.4 - 15.4 - 17.4 - 20.3	10.2 - 11.5 - 13.2 - 15.3 - 19.2
	Sound Level (SPL) (SLo-Lo-Mid-Hi-SH <sup>(3)</sup> )	Cooling	dB(A)	21 - 29 - 34 - 38 - 42	21 - 29 - 34 - 38 - 42	28 - 33 - 36 - 40 - 44	28 - 33 - 36 - 40 - 44	29 - 37 - 41 - 45 - 48	30 - 37 - 41 - 45 - 49
Heating		dB(A)	21 - 29 - 35 - 40 - 45	21 - 29 - 35 - 40 - 45	28 - 33 - 38 - 43 - 48	28 - 33 - 38 - 43 - 48	30 - 37 - 41 - 45 - 48	30 - 37 - 41 - 45 - 51	
Sound Level (PWL)	Cooling	dB(A)	57	57	58	58	65	65	
Dimensions	H*W*D	mm	550-800-285	550-800-285	714-800-285	714-800-285	714-800-285	880-840-330	
Weight	kg		35	35	40	40	40	55	
Outdoor Unit	Air Volume	Cooling	m <sup>3</sup> /min	30.4	30.4	40.5	40.5	52.1	54.1
		Heating	m <sup>3</sup> /min	32.7	32.7	40.5	40.5	52.1	47.9
	Sound Level (SPL)	Cooling	dB(A)	50	50	52	52	56	56
		Heating	dB(A)	51	51	52	52	57	55
	Sound Level (PWL)	Cooling	dB(A)	61	61	64	64	69	69
		Heating	dB(A)	61	61	64	64	69	69
	Operating Current (Max)	A	9.6	9.6	13.3	13.3	13.6	16.0	
Breaker Size	A	10	10	16	16	16	20		
Ext. Piping	Diameter	Liquid/Gas	mm	6.35 / 9.52	6.35 / 9.52	6.35 / 9.52	6.35 / 9.52	6.35 / 12.7	6.35 / 12.7
	Max.Length	Out-In	m	20	20	20	20	30	30
	Max.Height	Out-In	m	12	12	12	12	15	15
Guaranteed Operating Range (Outdoor)	Cooling	°C	-10 ~ +46	-10 ~ +46	-10 ~ +46	-10 ~ +46	-10 ~ +46	-10 ~ +46	
	Heating	°C	-15 ~ +24	-20 ~ +24	-15 ~ +24	-20 ~ +24	-15 ~ +24	-15 ~ +24	

(1) Refrigerant leakage contributes to climate change. Refrigerant with lower global warming potential (GWP) would contribute less to global warming than a refrigerant with higher GWP, if leaked to the atmosphere. This appliance contains a refrigerant fluid with a GWP equal to 550. This means that if 1 kg of this refrigerant fluid would be leaked to the atmosphere, the impact on global warming would be 550 times higher than 1 kg of CO<sub>2</sub> over a period of 100 years. Never try to interfere with the refrigerant circuit yourself or disassemble the product yourself and always ask a professional.  
The GWP of R32 is 675 in the IPCC 4th Assessment Report.

(2) Energy consumption based on standard test results. Actual energy consumption will depend on how the appliance is used and where it is located.

(3) SH: Super High

(4) SEER, SCOP and other related description are based on COMMISSION DELEGATED REGULATION (EU) No.626/2011. The temperature conditions for calculating SCOP are based on "Average Season".

(5) Please see page 51-52 for heating (warmer season) specifications.



# MSZ-F SERIES

MSZ-FH25/35/50VE2

**R410A**  
Single / Multi



The F Series is designed for optimum cooling/heating performance as well as operational comfort. Quiet, energy-saving operation is supported by some of Mitsubishi Electric's latest technologies. Advanced functions such as "3D i-see Sensor" temperature control and the Plasma Quad air purification system raise room comfort levels to new heights.

## High Energy Efficiency



Power consumption has been reduced for the cooling and heating modes thanks to the incorporation of our newest inverter technologies. The high energy efficiency of the Size 25 units has obtained a rating of more than 5.0 for both seasonal coefficient of performance (SCOP) and seasonal energy efficiency rating (SEER).

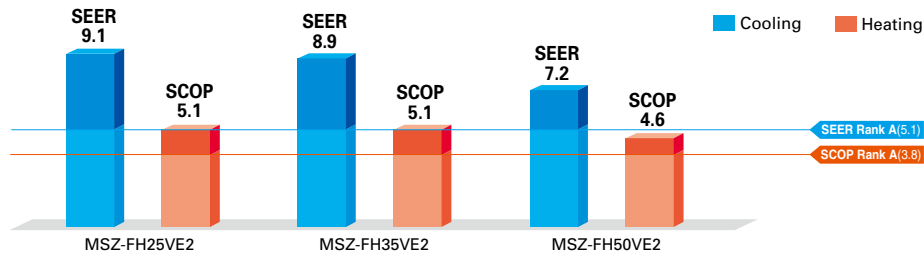

## 3D i-see Sensor

The FH Series is equipped with 3D i-see Sensor, an infrared-ray sensor that measures the temperature at distant positions. While moving to the left and right, eight vertically arranged sensor elements analyze the room temperature in three dimensions. This detailed analysis makes it possible to judge where people are in the room, thus allowing creation of features such as "Indirect airflow," to avoid airflow hitting people directly, and "direct airflow" to deliver airflow to where people are.

### Indirect Airflow

The indirect airflow setting can be used when the flow of air feels too strong or direct. For example, it can be used during cooling to avert airflow and prevent body temperature from becoming excessively cooled.



### Direct Airflow

This setting can be used to directly target airflow at people such as for immediate comfort when coming indoors on a hot (cold) day.



### Absence Detection

The sensors detect whether there are people in the room. When no-one is in the room, the unit automatically switches to energy-saving mode.

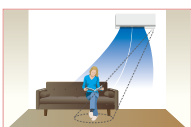

The "3D i-see Sensor" detects people's absence and the power consumption is automatically reduced approximately 10% after 10 minutes and 20% after 60 minutes.

## Plasma Quad

Air, like water, is something we use everyday unconsciously. Yet, clean, fresh air is a vital part of creating a healthy space for humans. Achieving this healthy air is Plasma Quad, a plasma-based filter system that effectively removes four kinds of air pollutants; namely, bacteria, viruses, allergens and dust, which the air contains countless particles of.

### Bacteria

Test results have confirmed that Plasma Quad neutralizes 99% of bacteria in 115 minutes in a 25m<sup>3</sup> test space.

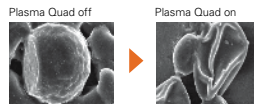

<Test No.> KRCEs-Bio\_Test Report No.23\_0317

### Viruses

Test results have confirmed that Plasma Quad neutralizes 99% of virus particles in 65 minutes in a 25m<sup>3</sup> test space.

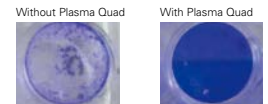

\* Hepatic cells turn transparent when affected by a virus.  
<Test No.> vrc.center, SMC No.23-002

### Allergens

In a test, air containing cat fur and pollen was passed through the air cleaning device at the low airflow setting. Before and after measurements confirm that Plasma Quad neutralizes 94% of cat fur and 98% of pollen.

<Test No.> ITEA No.12M-RPTFEB022

### Dust

In a test, air containing dust and ticks was passed through the air cleaning device at the low airflow setting. Before and after measurements confirm that Plasma Quad removes 88.6% of dust and ticks.

<Test No.> ITEA No.12M-RPTFEB022

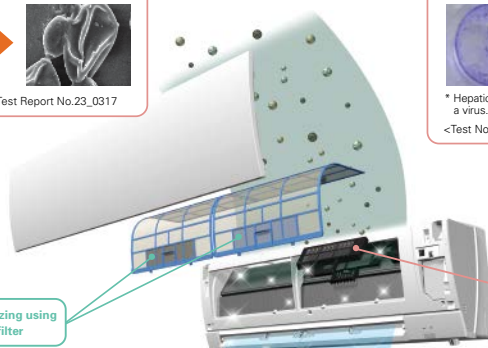

Effective deodorizing using the air-purifying filter

(Image)

# MSZ-F SERIES



## Indoor Unit

R410A



MSZ-FH25/35/50VE2

## Outdoor Unit

R410A



MUZ-FH25/35VE



MUZ-FH50VE

## Remote Controller



Type	Inverter Heat Pump			
Indoor Unit	MSZ-FH25VE2	MSZ-FH35VE2	MSZ-FH50VE2	
Outdoor Unit	MUZ-FH25VE	MUZ-FH35VE	MUZ-FH50VE	
Refrigerant	R410A <sup>(1)</sup>			
Power Source	Outdoor Power supply			
Supply	230/Single/50			
Cooling	Design load	kW	2.5	
	Annual electricity consumption <sup>(2)</sup>	kWh/a	96	
	SEER <sup>(4)</sup>		9.1	
	Energy efficiency class		A+++	
		Capacity	kW	3.5
Heating (Average Season) <sup>(3)</sup>	Design load	kW	3.0(-10°C)	
	Declared Capacity	at reference design temperature	kW	3.0(-10°C)
		at bivalent temperature	kW	3.0(-10°C)
	at operation limit temperature	kW	2.5(-15°C)	
	Back up heating capacity	kW	0.0(-10°C)	
Annual electricity consumption <sup>(2)</sup>	kWh/a	819		
SEER <sup>(4)</sup>		5.1		
Operating Current (Max)	Energy efficiency class		A+++	
		Capacity	kW	3.2
	Min-Max	kW	1.8-5.5	
	Total Input	kW	0.580	
	Rated	A	9.6	
Indoor Unit	Input	kW	0.029	
	Operating Current(Max)	A	0.4	
	Dimensions	H*W*D	305(+17)-925-234	
	Weight	kg	13.5	
	Outdoor Unit	Air Volume (SLo-Lo-Mid-Hi-SHi <sup>(5)</sup> (Dry/Wet))	m <sup>3</sup> /min	3.9-4.7-6.3-8.6-11.6
Sound Level (SPL)		dB(A)	20-23-29-36-42	
Sound Level (PWL)		dB(A)	58	
Operating Current (Max)		A	9.2	
Breaker Size		A	10	
Ext. Piping	Diameter	Liquid/Gas	6.35 / 9.52	
	Max.Length	Out-In	20	
	Max.Height	Out-In	12	
	Guaranteed Operating Range (Outdoor)	Cooling	°C	-10 ~ +46
	Heating	°C	-15 ~ +24	

(1) Refrigerant leakage contributes to climate change. Refrigerant with lower global warming potential (GWP) would contribute less to global warming than a refrigerant with higher GWP. If leaked to the atmosphere, the impact on global warming would be 1975 times higher than 1 kg of CO<sub>2</sub> over a period of 100 years. Never try to interfere with the refrigerant circuit yourself or disassemble the product yourself and always ask a professional.

The GWP of R410A is 2088 in the IPCC 4th Assessment Report.

(2) Energy consumption based on standard test results. Actual energy consumption will depend on how the appliance is used and where it is located.

(3) SHi: Super High

(4) SEER, SCOP and other related description are based on COMMISSION DELEGATED REGULATION (EU) No.626/2011. The temperature conditions for calculating SCOP are based on "Average Season".

(5) Please see page 51-52 for heating (warmer season) specifications.

# MSZ-E SERIES

Developed to complement modern interior room décor, Kirigamine ZEN air conditioners are available in three colours specially chosen to blend in naturally wherever installed.

MSZ-EF18-50VGB

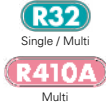

GOOD DESIGN reddot award 2015 winner



## Stylish Line-up Matches Any Room Décor

The streamlined wall-mounted indoor units have eloquent silver-bevelled edges, expressing sophistication and quality. Combining impressively low power consumption and quiet yet powerful performance, these units provide a best-match scenario for diverse interior designs while simultaneously ensuring maximum room and energy savings.



## Energy-efficient Operation



All models in the series have achieved high energy-savings rating, and are contributing to reduced energy consumption in homes, offices and a range of other settings. Offered in a variety of output capacities and installation patterns, the vast applicability promises an ideal match for any user.

Indoor \ Outdoor	Rank A for single connection MUZ-EF25/35VG(H) MUZ-EF42/50VG	Compatibility					
		MXZ					
		2F33VF	2F42VF	2F53VF	3F54VF	3F68VF	4F72VF
MSZ-EF18VG	-	✓	✓	✓	✓	✓	✓
MSZ-EF22VG	-	✓	✓	✓	✓	✓	✓
MSZ-EF25VG	A+++ / A++ (A+++)	✓	✓	✓	✓	✓	✓
MSZ-EF35VG	A+++ / A++ (A++)		✓	✓	✓	✓	✓
MSZ-EF42VG	A++ / A+			✓	✓	✓	✓
MSZ-EF50VG	A++ / A+			✓	✓	✓	✓

\*VEH

## Quiet Comfort All Day Long

Mitsubishi Electric's advanced "Silent Mode" fan speed setting provides super-quiet operation as low as 19dB for EF18/22/25 models for cooling. This unique feature makes the Kirigamine ZEN series ideal for use in any situation.

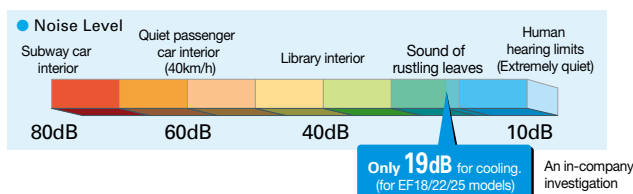

## Low Standby Power

Electrical devices consume standby power even when they are not in actual use. While we obviously strive to reduce power consumption during actual use, reducing this wasted power that cannot be seen is also very important.

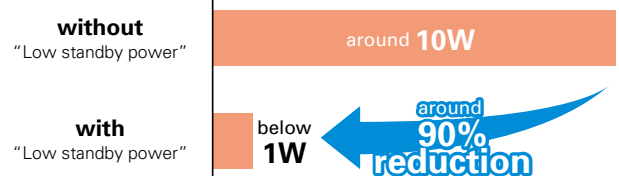

## Superior Exterior and Operating Design Concept

The indoor unit of the Kirigamine ZEN keeps its amazingly thin form even during operation. The only physical change notable is the movement of the variable vent. As a result, a slim attractive look is maintained.

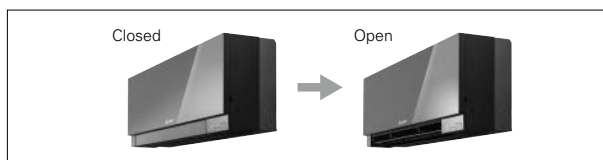

## Outdoor Units for Cold Region (25/35)

Single split-type outdoor units are available in both standard and heater-equipped units. An electric heater is installed in each unit to prevent freezing in cold outdoor environments.

Standard Units

Heater Installed



MUZ-EF25/35VG



MUZ-EF25/35VGH

# MSZ-E SERIES



## Indoor Unit / Remote Controller

R32 R410A



White

MSZ-EF18/22/25/35/42/50VG(K)W



Silver

MSZ-EF18/22/25/35/42/50VG(K)S



Black

MSZ-EF18/22/25/35/42/50VG(K)B\*

\* Soft-dry Cloth is enclosed with Black models.  
\* VGK model Wi-Fi interface built-in



## Outdoor Unit

R32



MUZ-EF25/35VG(H), 42VG



MUZ-EF50VG



Type	Inverter Heat Pump									
Indoor Unit	MSZ-EF18VG(K)	MSZ-EF22VG(K)	MSZ-EF25VG(K)	MSZ-EF25VG(K)	MSZ-EF35VG(K)	MSZ-EF35VG(K)	MSZ-EF42VG(K)	MSZ-EF50VG(K)	MSZ-EF50VG(K)	
Outdoor Unit	for MXZ connection		MUZ-EF25VG	MUZ-EF25VGH	MUZ-EF35VG	MUZ-EF35VGH	MUZ-EF42VG	MUZ-EF50VG	MUZ-EF50VG	
Refrigerant	R32 <sup>(1)</sup>									
Power Source	Outdoor Power supply									
Supply	230/Single/50									
Cooling	Design load	kW								
	Annual electricity consumption <sup>(2)</sup>	kWh/a								
	SEER <sup>(4)</sup>									
	Capacity	Energy efficiency class								
		Rated								
Heating (Average Season) <sup>(3)</sup>	Design load	kW								
	Declared Capacity	at reference design temperature								
		at bivalent temperature								
	Back up heating capacity	at operation limit temperature								
		at reference design temperature								
Annual electricity consumption <sup>(2)</sup>	kWh/a									
Operating Current (Max)	SEER <sup>(4)</sup>									
	Capacity	Energy efficiency class								
		Rated								
	Total Input	kW								
	Input	A								
Indoor Unit	Input	kW								
	Operating Current (Max)	A								
	Dimensions	H*W*D mm								
	Weight	kg								
	Air Volume (SLo-Lo-Mid-Hi-SH <sup>(5)</sup> (Dry/Wet))	Cooling	m <sup>3</sup> /min							
Heating		m <sup>3</sup> /min								
Sound Level (SPL)	Cooling	dB(A)								
	Heating	dB(A)								
Sound Level (PWL)	Cooling	dB(A)								
	Heating	dB(A)								
Outdoor Unit	Dimensions	H*W*D mm								
	Weight	kg								
	Air Volume	Cooling	m <sup>3</sup> /min							
		Heating	m <sup>3</sup> /min							
	Sound Level (SPL)	Cooling	dB(A)							
Heating		dB(A)								
Sound Level (PWL)	Cooling	dB(A)								
	Heating	dB(A)								
Operating Current (Max)	Cooling	A								
	Heating	A								
Ext. Piping	Breaker Size	A								
	Diameter	Liquid/Gas mm								
	Max.Length	m								
Guaranteed Operating Range (Outdoor)	Out-In	m								
	Out-In	m								
Guaranteed Operating Range (Outdoor)	Cooling	°C								
	Heating	°C								

<sup>(1)</sup> Refrigerant leakage contributes to climate change. Refrigerant with lower global warming potential (GWP) would contribute less to global warming than a refrigerant with higher GWP, if leaked to the atmosphere. This appliance contains a refrigerant fluid with a GWP equal to 550. This means that if 1 kg of this refrigerant fluid were leaked to the atmosphere, the impact on global warming would be 550 times higher than 1 kg of CO<sub>2</sub> over a period of 100 years. Never try to interfere with the refrigerant circuit yourself or disassemble the product yourself and always ask a professional.

The GWP of R32 is 675 in the IPCC 4th Assessment Report.

<sup>(2)</sup> Energy consumption based on standard test results. Actual energy consumption will depend on how the appliance is used and where it is located.

<sup>(3)</sup> SH: Super High

<sup>(4)</sup> SEER, SCOP and other related description are based on COMMISSION DELEGATED REGULATION (EU) No.626/2011. The temperature conditions for calculating SCOP are based on "Average Season".

<sup>(5)</sup> Please see page 51-52 for heating (warmer season) specifications.



# MSZ-S SERIES

# MSZ-G SERIES

Introducing a compact and stylish indoor unit with amazingly quiet performance. Not only are neat installations in small bedrooms possible, increase energy-savings by selecting the optimal capacity required for each room.



## “Rank A++/A+” Energy Savings Achieved for Entire Range of Series



All models in the series, from the low-capacity 25 to the high-capacity 71, have achieved the “Rank A++” for SEER and “Rank A+” for SCOP as energy-savings rating. For home use, such as in bedrooms and living rooms, to light commercial use, such as in offices, our air conditioners are contributing to reduced energy consumption in a wide range.

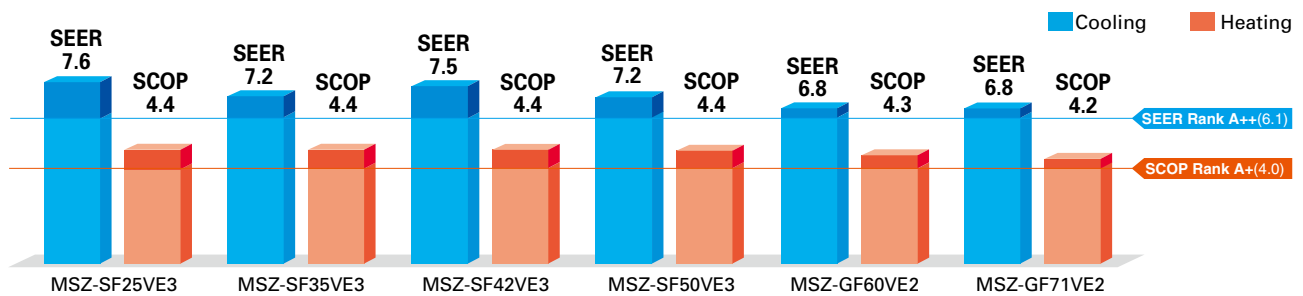

## Wide Line-up

Eight different indoor units (Model 15-71) are available to meet your diversified air conditioning needs.



MSZ-SF15 / 20VA\*  
\*for MXZ connection

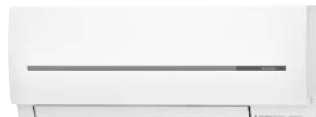

MSZ-SF25 / 35 / 42 / 50VE3



MSZ-GF60 / 71VE2

## Compact and Stylish

(MSZ-SF15/20VA)

The stylish, square indoor unit adds a touch of class to any room interior. The compact design is 64mm thinner than our previous indoor unit with the lowest output capacity (MSZ-GE22VA).

### Comparison with our previous model GE



## Family Design

(MSZ-SF15/20/25/35/42/50)

Models in the 25-50 class are introduced as single-split units while retaining the popular design of the SF15/20VA\* as indoor units exclusively for multi-systems. From small rooms to living rooms, it is possible to coordinate residences with a unified design.

\*Size may vary.



# “Weekly Timer”



Easily set desired temperatures and operation start/stop times to match lifestyle patterns. Reduce wasted energy consumption by using the timer to prevent forgetting to turn off the unit and eliminate temperature setting adjustments.

## ■ Example Operation Pattern (Winter/Heating mode)

	Mon.	Tues.	Wed.	Thurs.	Fri.	Sat.	Sun.
6:00	ON 20°C	ON 20°C	ON 20°C	ON 20°C	ON 20°C	ON 20°C	ON 20°C
8:00	Automatically changes to high-power operation at wake-up time						
10:00	OFF	OFF	OFF	OFF	OFF	ON 18°C	ON 18°C
12:00	Automatically turned off during work hours					Midday is warmer, so the temperature is set lower	
14:00							
16:00							
18:00	ON 20°C	ON 20°C	ON 20°C	ON 20°C	ON 20°C	ON 20°C	ON 20°C
20:00	Automatically turns on, synchronized with arrival at home					Automatically raises temperature setting to match time when outside-air temperature is low	
22:00 (during sleeping hours)	ON 18°C	ON 18°C	ON 18°C	ON 18°C	ON 18°C	ON 18°C	ON 18°C
	Automatically lowers temperature at bedtime for energy-saving operation at night						

**Settings** **Pattern Settings:** Input up to four settings for each day  
**Settings:** •Start/Stop operation •Temperature setting \*The operation mode cannot be set.

## ■ Easy set-up using dedicated buttons



The remote controller is equipped with buttons that are used exclusively for setting the Weekly Timer. Setting operation patterns is easy and quick.

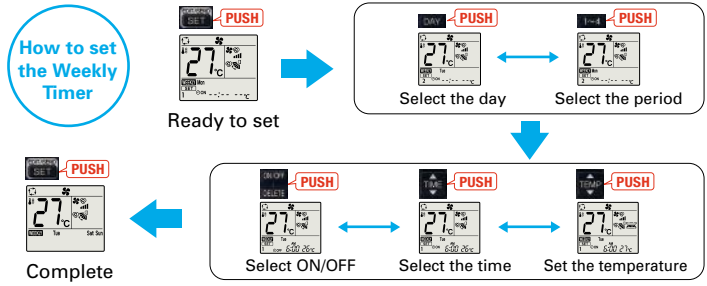

- Start by pushing the “SET” button and follow the instructions to set the desired patterns. Once all of the desired patterns are input, point the top end of the remote controller at the indoor unit and push the “SET” button one more time. (Push the “SET” button only after inputting all of the desired patterns into the remote controller memory. Pushing the “CANCEL” button will end the set-up process without sending the operation patterns to the indoor unit).
- It takes a few seconds to transmit the Weekly Timer operation patterns to the indoor unit. Please continue to point the remote controller at the indoor unit until all data has been sent.
- When “Weekly Timer” is set, temperature can not be set 10°C.

## Low Standby Power

Electrical devices consume standby power even when they are not in actual use. While we obviously strive to reduce power consumption during actual use, reducing this wasted power that cannot be seen is also very important.

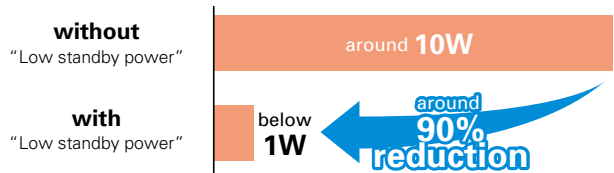

## Air Purifying Filter (MSZ-SF25/35/42/50, MSZ-GF60/71)

This filter generates stable antibacterial and deodorising effects. The size of the three-dimensional surface has been increased as well, enlarging the filter capture area. These features give the Air Purifying Filter better dust collection performance than conventional filters. The superior air-cleaning effectiveness raises room comfort yet another level.

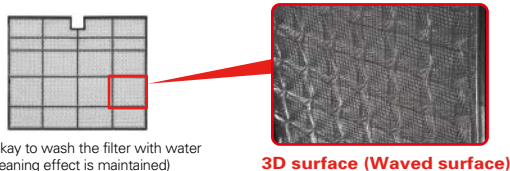

\* It is okay to wash the filter with water (air-cleaning effect is maintained)

3D surface (Waved surface)

## “i save” Mode



“i save” is a simplified setting function that recalls the preferred (preset) temperature by pressing a single button on the remote controller. Press the same button twice in repetition to immediately return to the previous temperature setting. Using this function contributes to comfortable, waste-free operation, realising the most suitable air conditioning settings and saving on power consumption when, for example, leaving the room or going to bed.

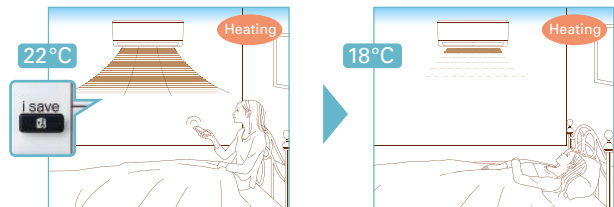

\* Temperature can be preset to 10°C when heating in the “i-save” mode.

## Outdoor Units for Cold Region (25/35/42/50)

Single split-type outdoor units are available in both standard and heater-equipped units. An electric heater is installed in each unit to prevent freezing in cold outdoor environments.



MUZ-SF25/35/42VE

MUZ-SF50VE

MUZ-SF25/35/42VEH

MUZ-SF50VEH

# MSZ-S SERIES



Indoor Unit

R410A



MSZ-SF15/20VA



Outdoor Unit

For MXZ Connection Only

Remote Controller



Type	Inverter Heat Pump										
Indoor Unit	MSZ-SF15VA		MSZ-SF20VA		MSZ-SF25VE3		MSZ-SF25VE3		MSZ-SF35VE3		
Outdoor Unit	for MXZ connection				MUZ-SF25VE		MUZ-SF25VEH		MUZ-SF35VE		
Refrigerant	R410A <sup>(1)</sup>										
Power Source	Outdoor Power supply										
Supply	Outdoor (V / Phase / Hz)										
	230/Single/50										
Cooling	Design load		-		2.5		2.5		3.5		
	Annual electricity consumption <sup>(2)</sup>	kWh/a	-		116		116		171		
	SEER <sup>(4)</sup>		-		7.6		7.6		7.2		
	Capacity	Energy efficiency class		-		A++		A++		A++	
		Rated	kW	-		2.5		2.5		3.5	
Heating (Average Season) <sup>(5)</sup>	Min-Max	kW	-		0.9-3.4		0.9-3.4		1.1-3.8		
	Total Input	Rated	-		0.600		0.600		1.080		
	Design load	kW	-		2.4(-10°C)		2.4(-10°C)		2.9(-10°C)		
	Declared Capacity	at reference design temperature	kW	-		2.4(-10°C)		2.4(-10°C)		2.9(-10°C)	
		at bivalent temperature	kW	-		2.4(-10°C)		2.4(-10°C)		2.9(-10°C)	
at operation limit temperature		kW	-		2.0(-15°C)		1.6(-20°C)		1.6(-20°C)		
Back up heating capacity	kW	-		0.0(-10°C)		0.0(-10°C)		0.0(-10°C)			
Annual electricity consumption <sup>(2)</sup>	kWh/a	-		764		790		923			
SCOP <sup>(4)</sup>		-		4.4		4.3		4.4			
Capacity	Energy efficiency class		-		A+		A+		A+		
	Rated	kW	-		3.2		3.2		4.0		
Total Input	Min-Max	kW	-		1.0-4.1		1.0-4.1		1.3-4.6		
	Rated	kW	-		0.780		0.780		1.030		
Operating Current (Max)		-		8.4		8.4		8.5			
Indoor Unit	Input	Rated	kW	0.017	0.019	0.024	0.024	0.027	0.027		
	Operating Current(Max)	A	0.17		0.19		0.2		0.3		
	Dimensions	H*W*D	mm 250-760-168		250-760-168		299-798-195		299-798-195		
	Weight	kg	7.7		7.7		10		10		
	Air Volume (SLo-Lo-Mid-Hi-SH <sup>(3)</sup> Dry/Wet)	Cooling	m <sup>3</sup> /min	3.5 - 3.9 - 4.6 - 5.5 - 6.4		3.5 - 3.9 - 4.6 - 5.5 - 6.9		3.2 - 4.1 - 5.6 - 7.2 - 9.1		3.2 - 4.1 - 5.6 - 7.2 - 9.1	
		Heating	m <sup>3</sup> /min	3.7 - 4.4 - 5.0 - 6.0 - 6.8		3.7 - 4.4 - 5.0 - 6.0 - 7.3		3.0 - 4.1 - 6.7 - 8.2 - 10.3		3.0 - 4.1 - 6.7 - 8.3 - 11.0	
	Sound Level (SPL) (SLo-Lo-Mid-Hi-SH <sup>(3)</sup> )	Cooling	dB(A)	21 - 26 - 30 - 35 - 40		21 - 26 - 30 - 35 - 42		19 <sup>(6)</sup> - 24 - 30 - 36 - 42		19 <sup>(6)</sup> - 24 - 30 - 36 - 42	
		Heating	dB(A)	21 - 26 - 30 - 35 - 40		21 - 26 - 30 - 35 - 42		19 <sup>(6)</sup> - 24 - 34 - 39 - 45		19 <sup>(6)</sup> - 24 - 34 - 39 - 45	
	Sound Level (PWL)	Cooling	dB(A)	59		60		57		57	
	Dimensions	H*W*D	mm -		-		550-800-285		550-800-285		
Weight	kg	-		-		31		31			
Outdoor Unit	Air Volume	Cooling	m <sup>3</sup> /min	-		31.1		31.1		35.9	
		Heating	m <sup>3</sup> /min	-		30.7		30.7		35.9	
	Sound Level (SPL)	Cooling	dB(A)	-		47		47		49	
		Heating	dB(A)	-		48		48		50	
	Sound Level (PWL)	Cooling	dB(A)	-		58		58		62	
Operating Current (Max)	A	-		8.2		8.2		8.2			
Breaker Size	A	-		10		10		10			
Ext. Piping	Diameter	Liquid/Gas	mm 6.35/9.52		6.35/9.52		6.35 / 9.52		6.35 / 9.52		
	Max.Length	Out-In	m -		-		20		20		
	Max.Height	Out-In	m -		-		12		12		
Guaranteed Operating Range (Outdoor)	Cooling	°C	-		-10 ~ +46		-10 ~ +46		-10 ~ +46		
	Heating	°C	-		-15 ~ +24		-20 ~ +24		-15 ~ +24		

(1) Refrigerant leakage contributes to climate change. Refrigerant with lower global warming potential (GWP) would contribute less to global warming than a refrigerant with higher GWP, if leaked to the atmosphere. This appliance contains a refrigerant fluid with a GWP equal to 1975. This means that if 1 kg of this refrigerant fluid would be leaked to the atmosphere, the impact on global warming would be 1975 times higher than 1 kg of CO<sub>2</sub>, over a period of 100 years. Never try to interfere with the refrigerant circuit yourself or disassemble the product yourself and always ask a professional.

The GWP of R410A is 2088 in the IPCC 4th Assessment Report.

(2) Energy consumption based on standard test results. Actual energy consumption will depend on how the appliance is used and where it is located.

(3) SH: Super High

(4) SEER, SCOP and other related description are based on COMMISSION DELEGATED REGULATION (EU) No.626/2011. The temperature conditions for calculating SCOP are based on "Average Season".

(5) Please see page 51-52 for heating (warmer season) specifications.

(6) For single use: only 19dB(A). For multi use (MX2): 21dB(A).

# MSZ-S SERIES MSZ-G SERIES



## Indoor Unit

R410A

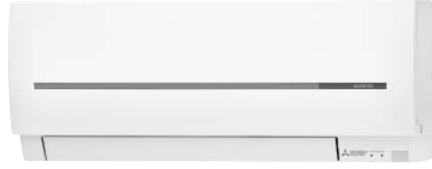

MSZ-SF25/35/42/50VE3



MSZ-GF60/71VE2

## Outdoor Unit

R410A



MUZ-SF25/35/42VE(H)



MUZ-SF50VE(H)  
MUZ-GF60/71VE

## Remote Controller



Type	Inverter Heat Pump								
Indoor Unit	MSZ-SF42VE3	MSZ-SF42VE3	MSZ-SF50VE3	MSZ-SF50VE3	MSZ-GF60VE2	MSZ-GF71VE2			
Outdoor Unit	MUZ-SF42VE	MUZ-SF42VEH	MUZ-SF50VE	MUZ-SF50VEH	MUZ-GF60VE	MUZ-GF71VE			
Refrigerant	R410A <sup>(1)</sup>								
Power Source	Outdoor Power supply								
Supply	Outdoor (V / Phase / Hz)								
							230/Single/50		
Cooling	Design load	kW	4.2	4.2	5.0	5.0	6.1	7.1	
	Annual electricity consumption <sup>(2)</sup>	kWh/a	196	196	246	246	311	364	
	SEER <sup>(4)</sup>		7.5	7.5	7.2	7.2	6.8	6.8	
	Energy efficiency class		A++	A++	A++	A++	A++	A++	
		Rated	kW	4.2	4.2	5.0	5.0	6.1	7.1
	Capacity	Min-Max	kW	0.8-4.5	0.8-4.5	1.4-5.4	1.4-5.4	1.4-7.5	2.0-8.7
Total Input	Rated	kW	1.340	1.340	1.660	1.660	1.790	2.130	
Heating (Average Season) <sup>(5)</sup>	Design load	kW	3.8 (-10°C)	3.8 (-10°C)	4.2 (-10°C)	4.2 (-10°C)	4.6 (-10°C)	6.7 (-10°C)	
	Declared Capacity	at reference design temperature	kW	3.8 (-10°C)	3.8 (-10°C)	4.2 (-10°C)	4.2 (-10°C)	4.6 (-10°C)	6.7 (-10°C)
		at bivalent temperature	kW	3.8 (-10°C)	3.8 (-10°C)	4.2 (-10°C)	4.2 (-10°C)	4.6 (-10°C)	6.7 (-10°C)
		at operation limit temperature	kW	3.4 (-15°C)	3.2 (-20°C)	3.4 (-15°C)	2.3 (-20°C)	3.7 (-15°C)	5.4 (-15°C)
	Back up heating capacity	kW	0.0 (-10°C)	0.0 (-10°C)	0.0 (-10°C)	0.0 (-10°C)	0.0 (-10°C)	0.0 (-10°C)	
	Annual electricity consumption <sup>(2)</sup>	kWh/a	1215	1242	1351	1380	1489	2204	
SCOP <sup>(4)</sup>			4.4	4.3	4.4	4.3	4.3	4.2	
	Energy efficiency class		A+	A+	A+	A+	A+	A+	
Capacity	Rated	kW	5.4	5.4	5.8	5.8	6.8	8.1	
	Min-Max	kW	1.3-6.0	1.3-6.0	1.4-7.3	1.4-7.3	2.0-9.3	2.2-9.9	
Total Input	Rated	kW	1.580	1.580	1.700	1.700	1.810	2.230	
Operating Current (Max)		A	9.5	9.5	12.3	12.3	14.5	16.6	
Indoor Unit	Input	Rated	kW	0.027	0.027	0.035	0.035	0.062	0.058
		Operating Current(Max)	A	0.3	0.3	0.3	0.3	0.5	0.5
	Dimensions	H*W*D	mm	299-798-195	299-798-195	299-798-195	299-798-195	325-1100-238	325-1100-238
	Weight	kg	10	10	10	10	16	16	
	Air Volume (SLo-Lo-Mid-Hi-SH <sup>(3)</sup> Dry/Wet)	Cooling	m <sup>3</sup> /min	4.7 - 5.8 - 6.7 - 7.9 - 9.1	4.7 - 5.8 - 6.7 - 7.9 - 9.1	5.1 - 6.2 - 7.0 - 8.2 - 9.9	5.1 - 6.2 - 7.0 - 8.2 - 9.9	9.8-11.3-13.4-15.6-18.3	9.7-11.5-13.3-15.4-17.8
		Heating	m <sup>3</sup> /min	4.7 - 5.8 - 7.2 - 9.1 - 11.4	4.7 - 5.8 - 7.2 - 9.1 - 11.4	5.1 - 6.4 - 8.0 - 9.8 - 12.0	5.1 - 6.4 - 8.0 - 9.8 - 12.0	9.8-11.3-13.4-15.6-18.3	10.2-11.5-13.3-15.4-17.8
	Sound Level (SPL) (SLo-Lo-Mid-Hi-SH <sup>(3)</sup> )	Cooling	dB(A)	26 <sup>(6)</sup> - 31 - 34 - 38 - 42	26 <sup>(6)</sup> - 31 - 34 - 38 - 42	28 <sup>(7)</sup> - 33 - 36 - 40 - 45	28 <sup>(7)</sup> - 33 - 36 - 40 - 45	29 - 37 - 41 - 45 - 49	30 - 37 - 41 - 45 - 49
		Heating	dB(A)	26 <sup>(6)</sup> - 31 - 36 - 42 - 47	26 <sup>(6)</sup> - 31 - 36 - 42 - 47	28 <sup>(7)</sup> - 33 - 38 - 43 - 49	28 <sup>(7)</sup> - 33 - 38 - 43 - 49	29 - 37 - 41 - 45 - 49	30 - 37 - 41 - 45 - 49
	Sound Level (PWL)	Cooling	dB(A)	57	57	58	58	65	65
		Heating	dB(A)	57	57	58	58	65	65
Dimensions	H*W*D	mm	550-800-285	550-800-285	880-840-330	880-840-330	880-840-330	880-840-330	
Weight	kg		35	35	55	55	50	53	
Outdoor Unit	Air Volume	Cooling	m <sup>3</sup> /min	35.2	35.2	44.6	44.6	49.2	50.1
		Heating	m <sup>3</sup> /min	33.6	33.6	44.6	44.6	49.2	48.2
	Sound Level (SPL)	Cooling	dB(A)	50	50	52	52	55	55
		Heating	dB(A)	51	51	52	52	55	55
	Sound Level (PWL)	Cooling	dB(A)	63	63	65	65	65	65
		Heating	dB(A)	63	63	65	65	65	65
Operating Current (Max)	A		9.2	9.2	12	12	14	16.1	
Breaker Size	A		10	10	16	16	20	20	
Ext. Piping	Diameter	Liquid/Gas	mm	6.35 / 9.52	6.35 / 9.52	6.35 / 12.7	6.35 / 12.7	6.35/15.88	9.52/15.88
	Max.Length	Out-In	m	20	20	30	30	30	30
	Max.Height	Out-In	m	12	12	15	15	15	15
Guaranteed Operating Range (Outdoor)	Cooling	°C	-10 ~ +46	-10 ~ +46	-10 ~ +46	-10 ~ +46	-10 ~ +46	-10 ~ +46	
	Heating	°C	-15 ~ +24	-20 ~ +24	-15 ~ +24	-20 ~ +24	-15 ~ +24	-15 ~ +24	

(1) Refrigerant leakage contributes to climate change. Refrigerant with lower global warming potential (GWP) would contribute less to global warming than a refrigerant with higher GWP, if leaked to the atmosphere. This appliance contains a refrigerant fluid with a GWP equal to 1975. This means that if 1 kg of this refrigerant fluid would be leaked to the atmosphere, the impact on global warming would be 1975 times higher than 1 kg of CO<sub>2</sub>, over a period of 100 years. Never try to interfere with the refrigerant circuit yourself or disassemble the product yourself and always ask a professional.  
The GWP of R410A is 2088 in the IPCC 4th Assessment Report.

(2) Energy consumption based on standard test results. Actual energy consumption will depend on how the appliance is used and where it is located.

(3) SH: Super High

(4) SEER, SCOP and other related description are based on COMMISSION DELEGATED REGULATION (EU) No.626/2011. The temperature conditions for calculating SCOP are based on "Average Season".

(5) Please see page 51-52 for heating (warmer season) specifications.

(6) For single use: only 26dB(A). For multi use (MX2): 28dB(A).

(7) For single use: only 28dB(A). For multi use (MX2): 30dB(A).

# MSZ-BT SERIES



MSZ-BT20/25/35/50VG(K)



## High Energy Efficiency for Entire Range of Series



All models in the series, from the low-capacity 20 to the high-capacity 50, have achieved the "Rank A++" for SEER and size 25 and 35 have achieved the "Rank A++" for SCOP as energy-savings rating. For home use, such as in bedrooms and living rooms, to light commercial use, such as in offices, our air conditioners are contributing to reduced energy consumption in a wide range.

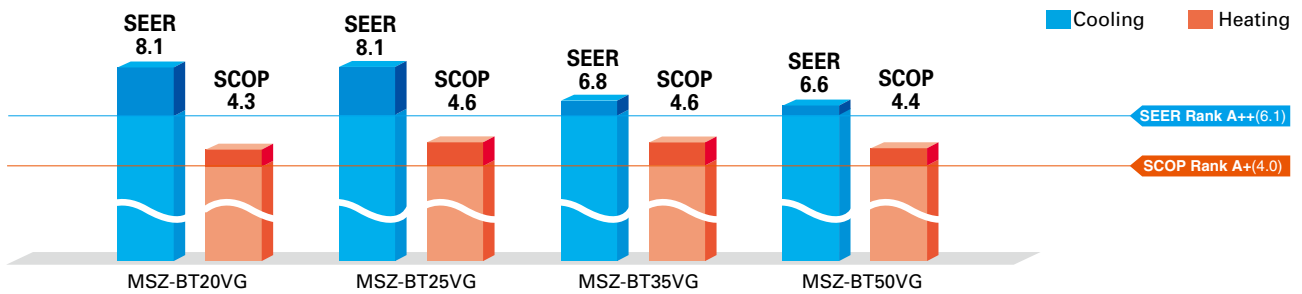

## Quiet Operation

The indoor unit noise level is as low as 19dB for AP Series, offering a peaceful inside environment.

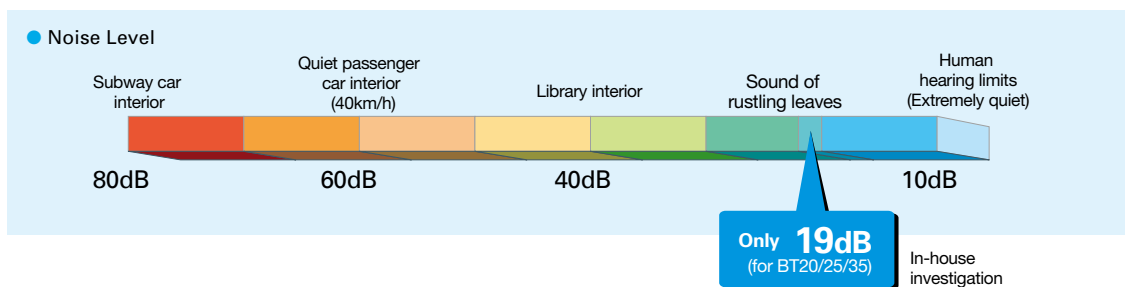

## New Remote Controller

New stylish and compact remote controller features easy-read big display and simple button position with fundamental functions.



## Built-in Wi-Fi Interface

(MSZ-BT20/25/35/50VGK)

The indoor unit is equipped with a Wi-Fi Interface inside an exclusive pocket in the unit.

This eliminates the need to install a Wi-Fi interface, and also contributes to the beautiful appearance since the interface is hidden.



# MSZ-BT SERIES



## Indoor Unit

R32

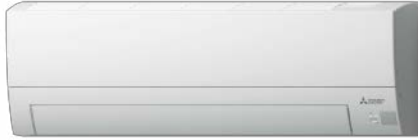

MSZ-BT20/25/35/50VG(K)

## Outdoor Unit



MUZ-BT20VG



MUZ-BT25/35VG



MUZ-BT50VG

## Remote Controller

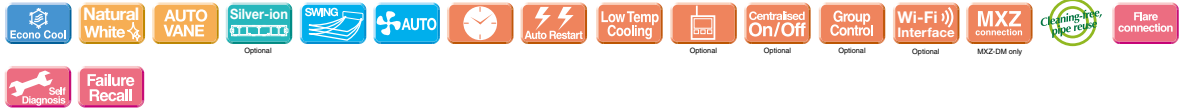

Type		Inverter Heat Pump					
Indoor Unit		MSZ-BT20VG	MSZ-BT25VG	MSZ-BT35VG	MSZ-BT50VG		
Outdoor Unit		MUZ-BT20VG	MUZ-BT25VG	MUZ-BT35VG	MUZ-BT50VG		
Refrigerant		R32 <sup>(1)</sup>					
Power Source		Outdoor Power supply					
Supply	Outdoor (V / Phase / Hz)	230V/Single/50Hz					
Cooling	Design load	kW	2.0	2.5	3.5	5.0	
	Annual electricity consumption <sup>(2)</sup>	kWh/a	86	108	180	265	
	SEER <sup>(4)</sup>		8.1	8.1	6.8	6.6	
	Capacity	Energy efficiency class		A++	A++	A++	A++
		Rated	kW	2.0	2.5	3.5	5.0
Heating (Average Season) <sup>(3)</sup>	Min-Max	kW	0.5-2.9	0.5-3.0	0.9-3.5	1.3-5.0	
	Total Input	Rated	kW	0.450	0.700	1.240	2.050
	Design load	kW	1.5 (-10°C)	1.9 (-10°C)	2.4 (-10°C)	3.8 (-10°C)	
	Declared Capacity	at reference design temperature	kW	1.5 (-10°C)	1.9 (-10°C)	2.4 (-10°C)	3.8 (-10°C)
		at bivalent temperature	kW	1.5 (-10°C)	1.9 (-10°C)	2.4 (-10°C)	3.8 (-10°C)
Back up heating capacity	at operation limit temperature	kW	1.3 (-15°C)	1.7 (-15°C)	2.1 (-15°C)	3.4 (-15°C)	
	Design load	kW	0.0 (-10°C)	0.0 (-10°C)	0.0 (-10°C)	0.0 (-10°C)	
	Annual electricity consumption <sup>(2)</sup>	kWh/a	487	577	727	1209	
	SCOP <sup>(4)</sup>		4.3	4.6	4.6	4.4	
	Capacity	Energy efficiency class		A+	A++	A++	A+
Rated		kW	2.5	3.15	3.6	5.4	
Total Input	Min-Max	kW	0.7-3.2	0.7-3.5	0.9-4.1	1.4-6.5	
	Rated	kW	0.550	0.750	0.930	1.550	
Operating Current (Max)	Input	A	5.6	7.0	7.0	10.0	
	Rated	kW	0.024	0.024	0.031	0.037	
Indoor Unit	Operating Current(Max)	A	0.25	0.25	0.31	0.35	
	Dimensions	H*W*D	mm	280-838-235	280-838-235	280-838-235	
	Weight		kg	9	9	9	
	Air Volume (Lo-Mid-Hi-SH) <sup>(5)</sup> (Dry/Wet)	Cooling	m <sup>3</sup> /min	4.2 - 5.2 - 6.8 - 8.7 - 10.9	4.2 - 5.2 - 6.8 - 8.7 - 10.9	4.2 - 5.2 - 6.8 - 8.7 - 13.2	6.3 - 7.6 - 9.0 - 11.0 - 13.2
		Heating	m <sup>3</sup> /min	4.2 - 5.0 - 6.8 - 9.0 - 11.9	4.2 - 5.0 - 6.8 - 9.0 - 11.9	4.2 - 5.0 - 6.8 - 9.0 - 11.9	6.0 - 7.8 - 9.9 - 11.9 - 14.1
	Sound Level (SPL) (Lo-Mid-Hi-SH) <sup>(5)</sup>	Cooling	dB(A)	19 - 22 - 30 - 37 - 43	19 - 22 - 30 - 37 - 43	19 - 22 - 31 - 38 - 46	29 - 33 - 36 - 40 - 46
		Heating	dB(A)	20 - 23 - 30 - 37 - 43	20 - 23 - 30 - 37 - 43	20 - 23 - 30 - 37 - 44	29 - 33 - 38 - 43 - 48
	Sound Level (PWL)	Cooling	dB(A)	57	57	60	60
		Heating	dB(A)	57	57	60	60
	Dimensions	H*W*D	mm	538-699-249	538-699-249	538-699-249	550-800-285
Outdoor Unit	Weight	kg	23	24	24	35	
	Air Volume	Cooling	m <sup>3</sup> /min	30.3	32.2	32.2	30.4
		Heating	m <sup>3</sup> /min	30.3	32.2	34.6	32.7
	Sound Level (SPL)	Cooling	dB(A)	50	50	52	50
		Heating	dB(A)	50	50	52	51
	Sound Level (PWL)	Cooling	dB(A)	63	63	64	64
		Heating	dB(A)	63	63	64	64
	Operating Current (Max)	A	5.3	6.7	6.7	9.6	
	Breaker Size	A	10	10	10	12	
	Ext. Piping	Diameter	Liquid/Gas	mm	6.35 / 9.52	6.35 / 9.52	6.35 / 12.7
Max.Length		Out-In	m	20	20	20	
Max.Height		Out-In	m	12	12	12	
Guaranteed Operating Range (Outdoor)	Cooling	°C	-10 ~ +46	-10 ~ +46	-10 ~ +46	-10 ~ +46	
	Heating	°C	-15 ~ +24	-15 ~ +24	-15 ~ +24	-15 ~ +24	

(1) Refrigerant leakage contributes to climate change. Refrigerant with lower global warming potential (GWP) would contribute less to global warming than a refrigerant with higher GWP, if leaked to the atmosphere. This appliance contains a refrigerant fluid with a GWP equal to 550. This means that if 1 kg of this refrigerant fluid would be leaked to the atmosphere, the impact on global warming would be 550 times higher than 1 kg of CO<sub>2</sub> over a period of 100 years. Never try to interfere with the refrigerant circuit yourself or disassemble the product yourself and always ask a professional.

The GWP of R32 is 675 in the IPCC 4th Assessment Report.

(2) Energy consumption based on standard test results. Actual energy consumption will depend on how the appliance is used and where it is located.

(3) SH: Super High

(4) SEER, SCOP and other related description are based on COMMISSION DELEGATED REGULATION (EU) No.626/2011. The temperature conditions for calculating SCOP are based on "Average Season".

(5) Please see page 51-52 for heating (warmer season) specifications.

# MSZ-HR SERIES

Compact, high-performance indoor and outdoor units with R32 that is low global warming potential compared with the current refrigerant R410A contribute to room comfort and to prevent global warming.

R32

MSZ-HR25/35/42/50VF



MSZ-HR60/71VF



## "Rank A++/A+" Energy Savings Achieved for Entire Range of Series



All models in the series, from capacity 25 to 71, have achieved the "Rank A++" for SEER and "Rank A+" for SCOP as energy-savings rating, thanks to Mitsubishi Electric's inverter technologies which are adopted to provide automatic adjustment of operation load according to need.

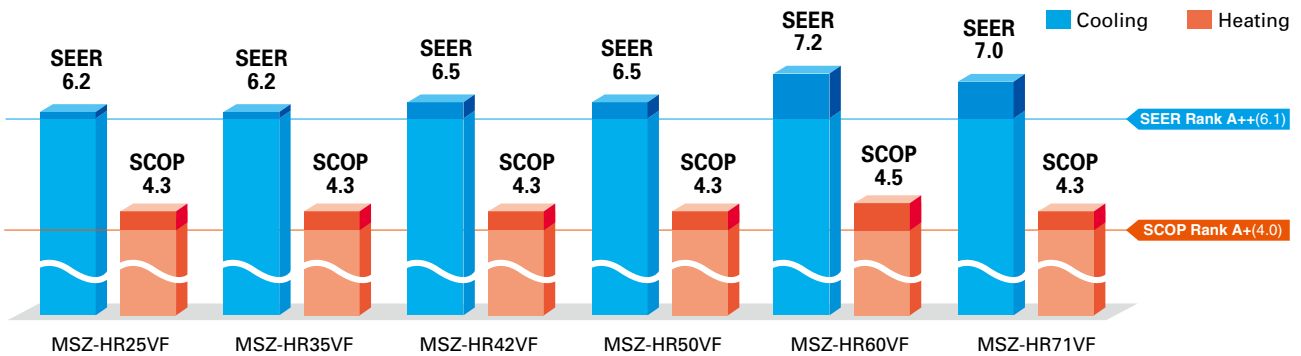

## Simple and Friendly Design

The round front surface provides a simple and friendly impression. And the width of indoor unit is compact, making installation in smaller, tighter spaces possible.

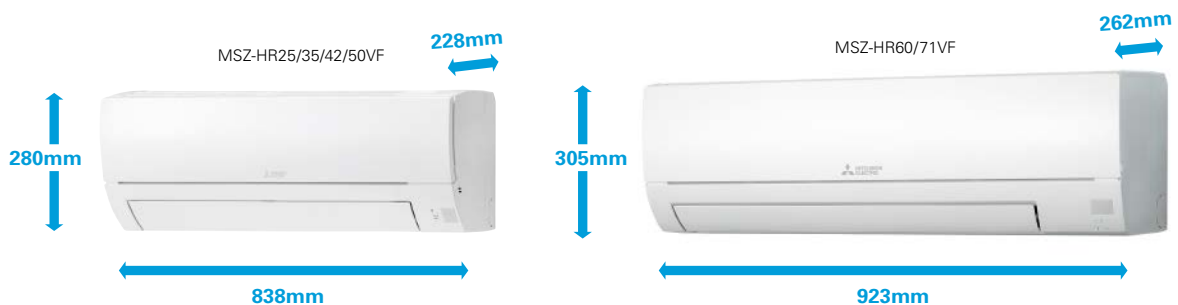

## Wi-Fi and System Control

### Wi-Fi Interface (Optional)

Optional interface enabling users to control air conditioners and check operating status via devices such as personal computers, tablets and smartphones.

### System Control Interface (Optional)

- Remote on/off operation is possible by input to the connector.
- Depending on the interface used, connecting a wired remote-control such as the PAR-40MAA is possible.
- Centralised control is possible when connected to M-NET.

\*Wi-Fi Interface and System Control Interface cannot be used simultaneously.

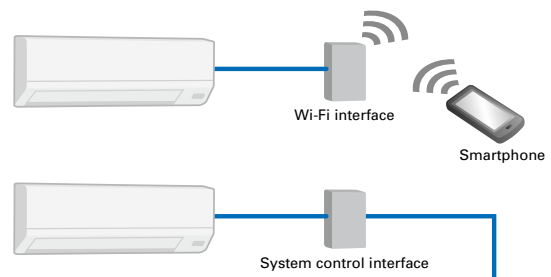

# MSZ-HR SERIES



## Indoor Unit R32



MSZ-HR25/35/42/50VF



MSZ-HR60/71VF

## Outdoor Unit



MUZ-HR25VF



MUZ-HR35VF



MUZ-HR42/50VF



MUZ-HR60/71VF

## Remote Controller

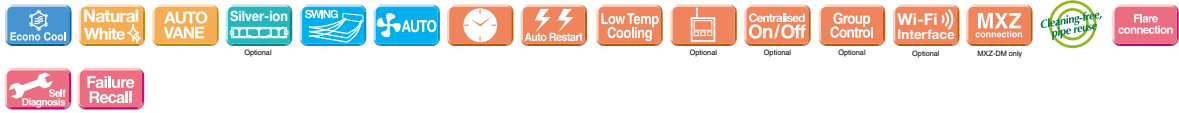

Type	Inverter Heat Pump									
Indoor Unit	MSZ-HR25VF	MSZ-HR35VF	MSZ-HR42VF	MSZ-HR50VF	MSZ-HR60VF	MSZ-HR71VF				
Outdoor Unit	MUZ-HR25VF	MUZ-HR35VF	MUZ-HR42VF	MUZ-HR50VF	MUZ-HR60VF	MUZ-HR71VF				
Refrigerant	R32 <sup>(1)</sup>									
Power Supply	Outdoor Power supply 230V/Single/50Hz									
Cooling	Design load	kW	2.5	3.4	4.2	5.0	6.1	7.1		
	Annual electricity consumption <sup>(2)</sup>	kWh/a	141	191	226	269	296	355		
	SEER <sup>(4)</sup>		6.2	6.2	6.5	6.5	7.2	7.0		
	Capacity	Energy efficiency class		A++	A++	A++	A++	A++	A++	
		Rated	kW	2.5	3.4	4.2	5.0	6.1	7.1	
Heating (Average Season) <sup>(3)</sup>	Declared Capacity	at reference design temperature	kW	1.9 (-10°C)	2.4 (-10°C)	2.9 (-10°C)	3.8 (-10°C)	4.6 (-10°C)	5.4 (-10°C)	
		at bivalent temperature	kW	1.9 (-10°C)	2.4 (-10°C)	2.9 (-10°C)	3.8 (-10°C)	4.6 (-10°C)	5.4 (-10°C)	
	at operation limit temperature	kW	1.9 (-10°C)	2.4 (-10°C)	2.9 (-10°C)	3.8 (-10°C)	4.6 (-10°C)	5.4 (-10°C)		
	Back up heating capacity	kW	0.0 (-10°C)	0.0 (-10°C)	0.0 (-10°C)	0.0 (-10°C)	0.0 (-10°C)	0.0 (-10°C)		
	Annual electricity consumption <sup>(2)</sup>	kWh/a	614	781	928	1224	1430	1755		
Operating Current (Max)	SCOP <sup>(4)</sup>	Energy efficiency class		A+	A+	A+	A+	A+		
		Rated	kW	3.15	3.6	4.7	5.4	6.8	8.1	
	Min-Max	kW	0.7-3.5	0.9-3.7	0.9-5.4	1.4-6.5	1.5-8.5	1.5-9.0		
	Total Input	Rated	kW	0.850	0.975	1.300	1.550	1.810	2.440	
	Input	Rated	A	5.0	6.7	8.5	10.0	14.1	14.1	
Indoor Unit	Operating Current (Max)	Input	kW	0.020	0.028	0.032	0.039	0.055	0.055	
		A	0.2	0.27	0.3	0.36	0.5	0.5		
	Dimensions	H*W*D	mm	280-838-228	280-838-228	280-838-228	280-838-228	305-923-262	305-923-262	
	Weight	kg	8.5	8.5	9	9	12.5	12.5		
	Air Volume (Lo-Mid-Hi-SH <sup>(5)</sup> /Dry/Wet)	Cooling	m <sup>3</sup> /min	3.6 - 5.4 - 7.2 - 9.7	3.6 - 5.6 - 7.8 - 11.7	6.0 - 8.7 - 10.8 - 13.1	6.4 - 9.2 - 11.2 - 13.1	10.4 - 12.6 - 15.4 - 19.6	10.4 - 12.6 - 15.4 - 19.6	
			m <sup>3</sup> /min	3.3 - 5.4 - 7.4 - 10.1	3.3 - 5.4 - 7.4 - 10.5	5.6 - 7.9 - 10.8 - 13.4	6.1 - 8.3 - 11.2 - 14.5	10.7 - 13.1 - 16.7 - 19.6	10.7 - 13.1 - 16.7 - 19.6	
		Sound Level (SPL) (Lo-Mid-Hi-SH <sup>(5)</sup> )	Cooling	dB(A)	21 - 30 - 37 - 43	22 - 31 - 38 - 46	24 - 34 - 39 - 45	28 - 36 - 40 - 45	33 - 38 - 44 - 50	33 - 38 - 44 - 50
			Heating	dB(A)	21 - 30 - 37 - 43	21 - 30 - 37 - 44	24 - 32 - 40 - 46	27 - 34 - 41 - 47	33 - 38 - 44 - 50	33 - 38 - 44 - 50
	Sound Level (PWL)	Cooling	dB(A)	57	60	60	60	65	65	
		Heating	dB(A)	57	60	60	60	65	65	
Outdoor Unit	Dimensions	H*W*D	mm	538-699-249	538-699-249	550-800-285	550-800-285	714-800-285	714-800-285	
		Weight	kg	23	24	34	35	40	40	
	Air Volume	Cooling	m <sup>3</sup> /min	30.3	32.2	30.4	30.4	42.8	42.8	
		Heating	m <sup>3</sup> /min	30.3	32.2	32.7	32.7	48.3	48.3	
	Sound Level (SPL)	Cooling	dB(A)	50	51	50	50	53	53	
		Heating	dB(A)	50	51	51	51	57	57	
	Sound Level (PWL)	Cooling	dB(A)	63	64	64	64	65	66	
		Heating	dB(A)	63	64	64	64	65	66	
	Operating Current (Max)	A	4.8	6.4	8.2	9.6	13.6	13.6		
	Breaker Size	A	10	10	10	12	16	16		
Ext. Piping	Diameter	Liquid/Gas	mm	6.35 / 9.52	6.35 / 9.52	6.35 / 9.52	6.35 / 9.52	6.35 / 12.7	6.35 / 12.7	
	Max.Length	Out-In	m	20	20	20	20	30	30	
	Max.Height	Out-In	m	12	12	12	12	15	15	
Guaranteed Operating Range (Outdoor)	Cooling	°C	-10 ~ +46	-10 ~ +46	-10 ~ +46	-10 ~ +46	-10 ~ +46	-10 ~ +46		
	Heating	°C	-10 ~ +24	-10 ~ +24	-10 ~ +24	-10 ~ +24	-10 ~ +24	-10 ~ +24		

<sup>(1)</sup> Refrigerant leakage contributes to climate change. Refrigerant with lower global warming potential (GWP) would contribute less to global warming than a refrigerant with higher GWP. If leaked to the atmosphere, this appliance contains a refrigerant fluid with a GWP equal to 550. This means that if 1 kg of this refrigerant fluid would be leaked to the atmosphere, the impact on global warming would be 550 times higher than 1 kg of CO<sub>2</sub> over a period of 100 years. Never try to interfere with the refrigerant circuit yourself or disassemble the product yourself and always ask a professional.

The GWP of R32 is 675 in the IPCC 4th Assessment Report.

<sup>(2)</sup> Energy consumption based on standard test results. Actual energy consumption will depend on how the appliance is used and where it is located.

<sup>(3)</sup> SH: Super High

<sup>(4)</sup> SEER, SCOP and other related description are based on COMMISSION DELEGATED REGULATION (EU) No.626/2011. The temperature conditions for calculating SCOP are based on "Average Season".

<sup>(5)</sup> Please see page 51-52 for heating (warmer season) specifications.

# MSZ-W SERIES

R410A

MSZ-WN25/35VA



Introducing a stylish indoor unit with high-performance air purifying filters. Wi-Fi and system controller connectivity, and a heating operation range down to -15°C contribute to greater room comfort.

## Advanced Inverter Control – Efficient Operation All the Time



Mitsubishi Electric's cutting-edge inverter technologies are adopted to provide automatic adjustment of operation load according to need. This reduces excessive consumption of electricity, and thereby realises an Energy Rank "A+".

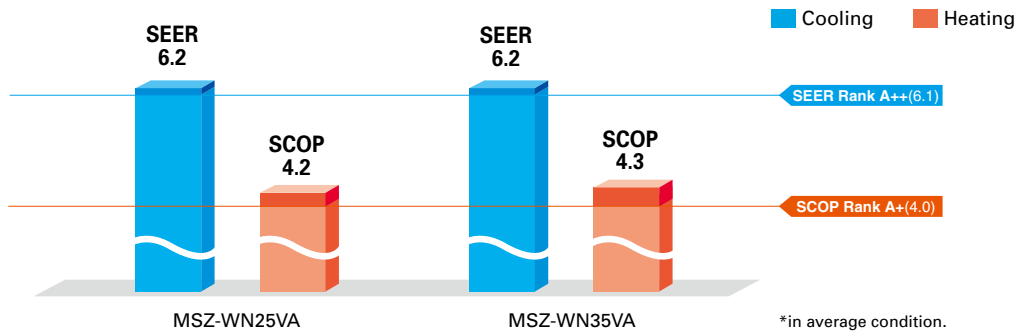

## Wider Heating Operating Range

As a result of an extended operating range in heating, these models accommodate a wider range of usage environments and applications than previous models.

### Operating Range (Heating)



## Wi-Fi and System Control

### Wi-Fi Interface (Optional)

Optional interface enabling users to control air conditioners and check operating status via devices such as personal computers, tablets and smartphones.

### System Control Interface (Optional)

- Remote on/off operation is possible by input to the connector.
- Depending on the interface used, connecting a wired remote control such as the PAR-40MAA is possible.
- Centralised control is possible when connected to M-NET.

\*Wi-Fi Interface and System Control Interface cannot be used simultaneously.

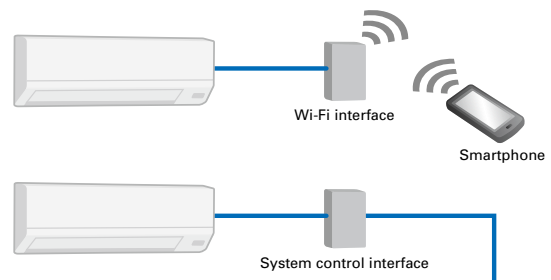

## Silver-ionized Air Purifying Filter

The high performance filter is attached as standard. Captures the bacteria, pollen and other allergens in the air and neutralises them.

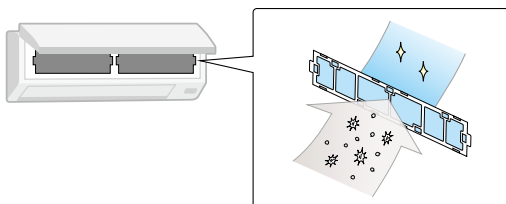

## Air Purifying Filter

This filter generates stable antibacterial and deodorising effects. The size of the three-dimensional surface has been increased as well, enlarging the filter capture area. These features give the Air Purifying Filter better dust collection performance than conventional filters. The superior air-cleaning effectiveness raises room comfort yet another level.

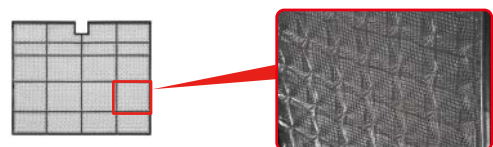

\* It is okay to wash the filter with water (air-cleaning effect is maintained)

3D surface (Waved surface)

# MSZ-W SERIES



## Indoor Unit

R410A



MSZ-WN25/35VA

## Outdoor Unit

R410A



MUZ-WN25/35VA

## Remote Controller

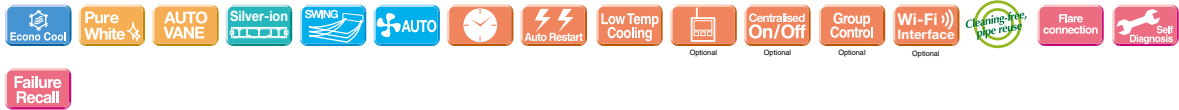

Type	Inverter Heat Pump			
Indoor Unit	MSZ-WN25VA		MSZ-WN35VA	
Outdoor Unit	MUZ-WN25VA		MUZ-WN35VA	
Refrigerant	R410A <sup>(1)</sup>			
Power Source	Indoor Power Supply			
Supply	Outdoor ( V / Phase / Hz )			
			230V/Single/50Hz	
Cooling	Design load	kW	2.5	
	Annual electricity consumption <sup>(2)</sup>	kWh/a	141	
	SEER <sup>(4)</sup>		6.2	
	Energy efficiency class			A++
				A++
Capacity	Rated	kW	2.5	
	Min-Max	kW	1.3 - 3.0	
Total Input	Rated	kW	0.710	
			1.020	
Heating (Average Season) <sup>(3)</sup>	Design load	kW	1.9(-10°C)	
	Declared Capacity	at reference design temperature	kW	1.9(-10°C)
		at bivalent temperature	kW	1.9(-10°C)
		at operation limit temperature	kW	1.6(-15°C)
	Back up heating capacity	kW	0.0(-10°C)	
	Annual electricity consumption <sup>(2)</sup>	kWh/a	628	
	SCOP <sup>(4)</sup>		4.2	
	Energy efficiency class			A+
			A+	
Capacity	Rated	kW	3.15	
	Min-Max	kW	0.9 - 3.5	
Total Input	Rated	kW	0.850	
			0.975	
Operating Current (Max)		A	5.8	
	Input	Rated	kW	0.020
Indoor Unit	Operating Current(Max)	A	0.3	
	Dimensions	H*W*D	mm	
	Weight	kg	9	
	Air Volume (Lo-Mid-Hi-SH <sup>(5)</sup> (Dry/Wet))	Cooling	m <sup>3</sup> /min	3.8 - 5.5 - 7.3 - 9.5
		Heating	m <sup>3</sup> /min	3.5 - 5.5 - 7.5 - 10.0
Sound Level (SPL) (Lo-Mid-Hi-SH <sup>(5)</sup> )	Cooling	dB(A)	22 - 30 - 37 - 43	
	Heating	dB(A)	23 - 30 - 37 - 43	
Sound Level (PWL)	Cooling	dB(A)	57	
			60	
Outdoor Unit	Dimensions	H*W*D	mm	
	Weight	kg	24	
	Air Volume	Cooling	m <sup>3</sup> /min	31.5
		Heating	m <sup>3</sup> /min	31.5
	Sound Level (SPL)	Cooling	dB(A)	50
Heating		dB(A)	50	
Sound Level (PWL)	Cooling	dB(A)	63	
			64	
Operating Current (Max)		A	5.5	
	Breaker Size	A	10	
Ext. Piping	Diameter	Liquid/Gas	mm	
	Max.Length	Out-In	m	
	Max.Height	Out-In	m	
Guaranteed Operating Range (Outdoor)	Cooling	°C	-10 - +46	
	Heating	°C	-15 - +24	

(1) Refrigerant leakage contributes to climate change. Refrigerant with lower global warming potential (GWP) would contribute less to global warming than a refrigerant with higher GWP, if leaked to the atmosphere. This appliance contains a refrigerant fluid with a GWP equal to 1975. This means that if 1 kg of this refrigerant fluid would be leaked to the atmosphere, the impact on global warming would be 1975 times higher than 1 kg of CO<sub>2</sub> over a period of 100 years. Never try to interfere with the refrigerant circuit yourself or disassemble the product yourself and always ask a professional.

The GWP of R410A is 2088 in the IPCC 4th Assessment Report.

(2) Energy consumption based on standard test results. Actual energy consumption will depend on how the appliance is used and where it is located.

(3) SH: Super High

(4) SEER, SCOP and other related description are based on COMMISSION DELEGATED REGULATION (EU) No.626/2011. The temperature conditions for calculating SCOP are based on "Average Season".

(5) Please see page 51-52 for heating (warmer season) specifications.



# MSY-TP SERIES

Cooling only model with high-performance provide high SHF in various environments thanks to wide operation range.

R32

MSY-TP35/50VF



## High Energy-Saving Performance with High SHF

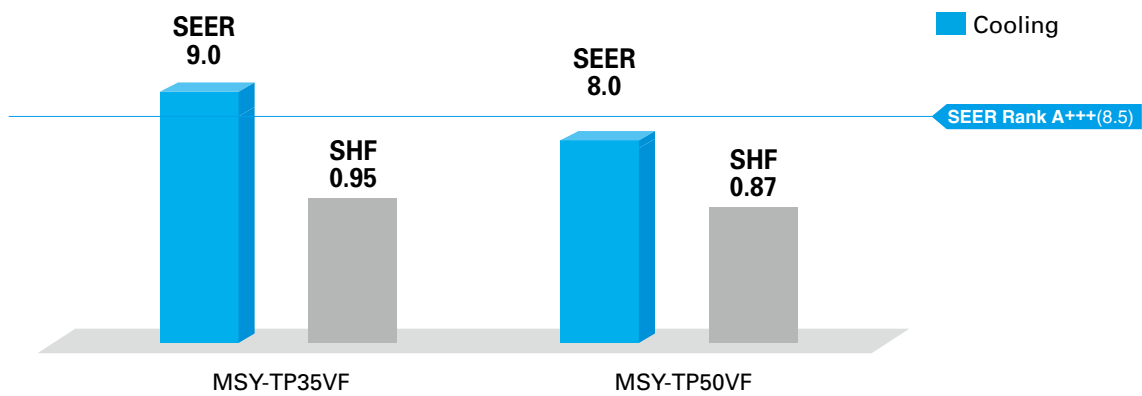

## Wide Cooling Operating Range

As a result of an extended operating range in cooling, these models accommodate a wide range of usage environments and applications.

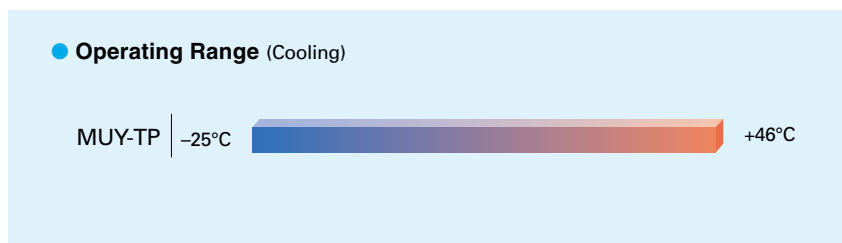

# MSY-TP SERIES



## Indoor Unit R32



MSY-TP35/50VF

## Outdoor Unit R32



MUY-TP35/TP50VF

## Remote Controller

- Wired remote controller can be connected to indoor unit.

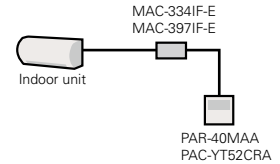

Type		Inverter Heat Pump			
Indoor Unit		MSY-TP35VF		MSY-TP50VF	
Outdoor Unit		MUY-TP35VF		MUY-TP50VF	
Refrigerant		R32 <sup>(1)</sup>			
Power Supply		Indoor Power supply			
Source		230V / Single / 50Hz			
Outdoor ( V / Phase / Hz )					
Cooling	Design load	kW	3.5	5.0	
	Annual electricity consumption <sup>(2)</sup>	kWh/a	136	218	
	SEER <sup>(4)</sup>		9.0	8.0	
	Capacity	Energy efficiency class		A+++	A++
		Rated	kW	3.5	5.0
	Total Input	Min-Max	kW	1.5 - 4.0	1.5 - 5.7
Rated		kW	0.760	1.450	
Heating (Average Season) <sup>(3)</sup>	Design load	kW	-	-	
	Declared Capacity	at reference design temperature	kW	-	-
		at bivalent temperature	kW	-	-
		at operation limit temperature	kW	-	-
	Back up heating capacity	kW	-	-	
	Annual electricity consumption <sup>(2)</sup>	kWh/a	-	-	
	SCOP <sup>(4)</sup>		-	-	
	Energy efficiency class			-	-
Capacity	Rated	kW	-	-	
	Min-Max	kW	-	-	
Total Input	Rated	kW	-	-	
Operating Current (Max)		A	9.6	9.6	
Indoor Unit	Input	Rated	kW	0.033	0.034
		Operating Current (Max)	A	0.4	0.4
	Dimensions	H*W*D	mm	305-923-250	305-923-250
	Weight	kg		12.5	12.5
	Air Volume (Lo-Mid-Hi-SH) <sup>(3)</sup> (Dry/Wet)	Cooling	m <sup>3</sup> /min	10.1 - 11.6 - 13.7 - 16.4	10.1 - 11.6 - 13.7 - 16.4
		Heating	m <sup>3</sup> /min	-	-
	Sound Level (SPL) (Lo-Mid-Hi-SH) <sup>(3)</sup>	Cooling	dB(A)	31 - 36 - 40 - 45	31 - 36 - 40 - 45
		Heating	dB(A)	-	-
	Sound Level (PWL)	Cooling	dB(A)	60	60
	Breaker Size	A		10	10
Outdoor Unit	Dimensions	H*W*D	mm	550-800-285	550-800-285
	Weight	kg		34	34
		Air Volume	Cooling	m <sup>3</sup> /min	29.3
	Sound Level (SPL)	Heating	m <sup>3</sup> /min	-	-
		Cooling	dB(A)	45	47
	Sound Level (PWL)	Heating	dB(A)	-	-
		Cooling	dB(A)	58	61
Operating Current (Max)	A		9.2	9.2	
Ext. Piping	Diameter	Liquid/Gas	mm	6.35/9.52	6.35/9.52
	Max.Length	Out-In	m	20	20
	Max.Height	Out-In	m	12	12
Guaranteed Operating Range (Outdoor)	Cooling	°C	-25 - +46	-25 - +46	
	Heating	°C	-	-	

(1) Refrigerant leakage contributes to climate change. Refrigerant with lower global warming potential (GWP) would contribute less to global warming than a refrigerant with higher GWP, if leaked to the atmosphere. This appliance contains a refrigerant fluid with a GWP equal to 550. This means that if 1 kg of this refrigerant fluid would be leaked to the atmosphere, the impact on global warming would be 550 times higher than 1 kg of CO<sub>2</sub> over a period of 100 years. Never try to interfere with the refrigerant circuit yourself or disassemble the product yourself and always ask a professional.

The GWP of R32 is 675 in the IPCC 4th Assessment Report.

(2) Energy consumption based on standard test results. Actual energy consumption will depend on how the appliance is used and where it is located.

(3) SH: Super High

(4) SEER and other related description are based on COMMISSION DELEGATED REGULATION (EU) No.626/2011.

# MSZ-D SERIES

R410A

MSZ-DM25/35VA



Compact, high-performance indoor and outdoor units equipped with high-performance air purifying filters contribute to greater room comfort. Wi-Fi and system controller connectivity enable enhanced expandability.

## Advanced Inverter Control – Efficient Operation All the Time



Mitsubishi Electric's cutting-edge inverter technologies are adopted to provide automatic adjustment of operation load according to need. This reduces excessive consumption of electricity, and thereby realises an Energy Rank "A+".

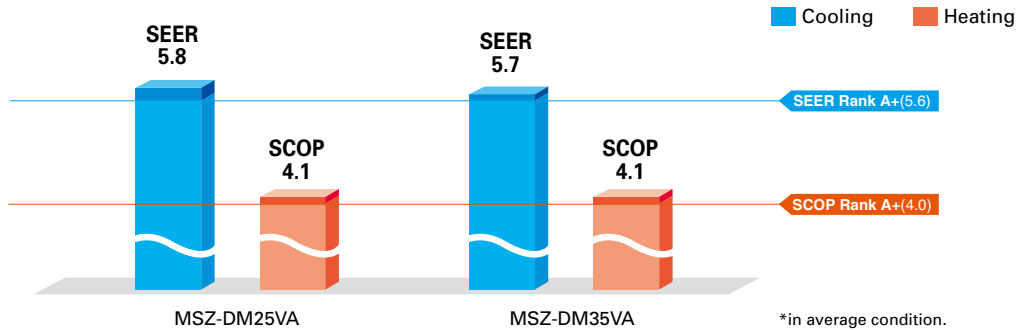

## Wider Cooling Operating Range

As a result of an extended operating range in cooling, these models accommodate a wider range of usage environments and applications than previous models.

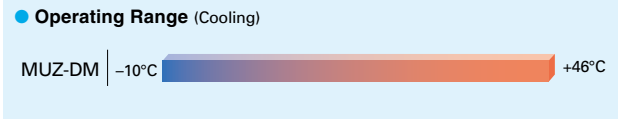

## Wi-Fi and System Control

### Wi-Fi Interface (Optional)

Optional interface enabling users to control air conditioners and check operating status via devices such as personal computers, tablets and smartphones.

### System Control Interface (Optional)

- Remote on/off operation is possible by input to the connector.
- Depending on the interface used, connecting a wired remote control such as the PAR-40MAA is possible.
- Centralised control is possible when connected to M-NET.

\*Wi-Fi Interface and System Control Interface cannot be used simultaneously.

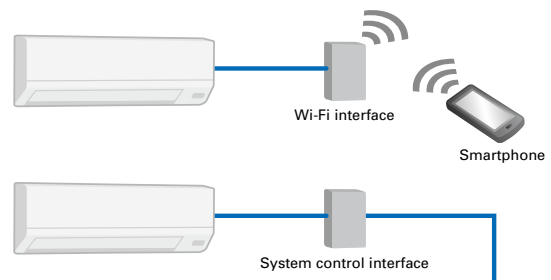

## Silver-ionized Air Purifying Filter

The high performance filter is attached as standard. Captures the bacteria, pollen and other allergens in the air and neutralises them.

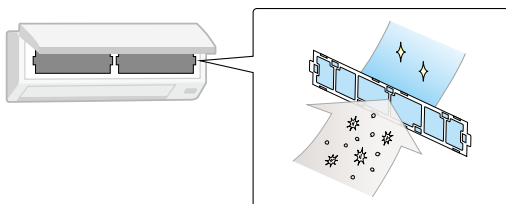

## Compact Units

The width of both indoor and outdoor units are compact, making installation in smaller, tighter spaces possible.

Indoor Unit: MSZ-DM25VA

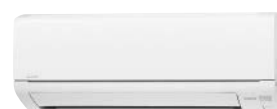

Only 799mm width

Outdoor Unit: MUZ-DM25/35VA



Only 699mm width

# MSZ-D SERIES



## Indoor Unit

R410A



MSZ-DM25/35VA

## Outdoor Unit

R410A



MUZ-DM25/35VA

## Remote Controller

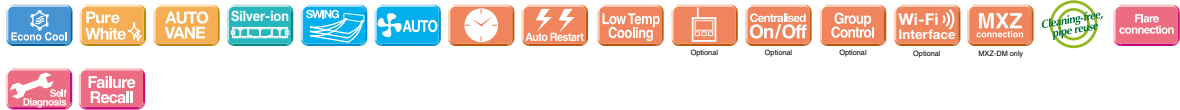

Type	Inverter Heat Pump			
Indoor Unit	MSZ-DM25VA		MSZ-DM35VA	
Outdoor Unit	MUZ-DM25VA		MUZ-DM35VA	
Refrigerant	R410A <sup>(1)</sup>			
Power Source	Indoor Power supply			
Supply	Outdoor ( V / Phase / Hz )			
		230V/Single/50Hz		
Cooling	Design load	kW	2.5	
	Annual electricity consumption <sup>(2)</sup>	kWh/a	149	
	SEER <sup>(4)</sup>		5.8	
	Energy efficiency class			A <sup>+</sup>
		Capacity	kW	3.15
	Rated		2.5	
	Min-Max		1.3 - 3.0	
	Total Input	kW	0.710	
	Rated		1.020	
Heating (Average Season) <sup>(3)</sup>	Design load	kW	1.9 (-10°C)	
	Declared Capacity	at reference design temperature	kW	1.9 (-10°C)
		at bivalent temperature	kW	1.9 (-10°C)
		at operation limit temperature	kW	1.9 (-10°C)
	Back up heating capacity	kW	0.0 (-10°C)	
	Annual electricity consumption <sup>(2)</sup>	kWh/a	647	
	SCOP <sup>(4)</sup>		4.1	
	Energy efficiency class			A <sup>+</sup>
Capacity		kW	3.6	
	Rated		3.15	
	Min-Max		0.9 - 3.5	
	Total Input	kW	0.850	
	Rated		0.975	
Operating Current (Max)	Input	A	5.8	
	Rated		0.020	
	Operating Current(Max)	A	0.3	
	Dimensions	H*W*D	290-799-232	
Indoor Unit	Weight	kg	9	
	Air Volume (SLo-Lo-Mid-Hi-SHi <sup>(5)</sup> Dry/Wet)	Cooling	m <sup>3</sup> /min	3.8 - 5.5 - 7.3 - 9.5
		Heating	m <sup>3</sup> /min	3.5 - 5.5 - 7.5 - 10.0
	Sound Level (SPL) (SLo-Lo-Mid-Hi-SHi <sup>(5)</sup> )	Cooling	dB(A)	22 - 30 - 37 - 43
		Heating	dB(A)	23 - 30 - 37 - 43
	Sound Level (PWL)	Cooling	dB(A)	57
	Dimensions	H*W*D	mm	538-699-249
Outdoor Unit	Weight	kg	24	
	Air Volume	Cooling	m <sup>3</sup> /min	31.5
		Heating	m <sup>3</sup> /min	31.5
	Sound Level (SPL)	Cooling	dB(A)	50
		Heating	dB(A)	51
	Sound Level (PWL)	Cooling	dB(A)	63
		Heating	dB(A)	64
Operating Current (Max)	A	5.5		
Breaker Size	A	10		
Ext. Piping	Diameter	Liquid/Gas	6.35/9.52	
	Max.Length	Out-In	20	
	Max.Height	Out-In	12	
Guaranteed Operating Range (Outdoor)	Cooling	°C	-10 ~ +46	
	Heating	°C	-10 ~ +24	

(1) Refrigerant leakage contributes to climate change. Refrigerant with lower global warming potential (GWP) would contribute less to global warming than a refrigerant with higher GWP, if leaked to the atmosphere. This appliance contains a refrigerant fluid with a GWP equal to 1975. This means that if 1 kg of this refrigerant fluid would be leaked to the atmosphere, the impact on global warming would be 1975 times higher than 1 kg of CO<sub>2</sub> over a period of 100 years. Never try to interfere with the refrigerant circuit yourself or disassemble the product yourself and always ask a professional.

The GWP of R410A is 2088 in the IPCC 4th Assessment Report.

(2) Energy consumption based on standard test results. Actual energy consumption will depend on how the appliance is used and where it is located.

(3) SHi: Super High

(4) SEER, SCOP and other related description are based on COMMISSION DELEGATED REGULATION (EU) No.626/2011. The temperature conditions for calculating SCOP are based on "Average Season".

(5) Please see page 51-52 for heating (warmer season) specifications.

# MSZ-H SERIES

Compact, high-performance indoor and outdoor units and advanced inverter technologies provide superior energy savings and comfort in all rooms.

R410A

MSZ-HJ25/35/50VA

MSZ-HJ60/71VA



## Stylish Design with Flat Panel Front

A stylish flat panel design is employed for the front of the indoor unit. The simple look matches room aesthetics.



## Advanced Inverter Control – Efficient Operation All the Time

DC Inverter



Mitsubishi Electric's cutting-edge inverter technologies are adopted to provide automatic adjustment of operation load according to need. This reduces excessive consumption of electricity, and thereby realises an Energy Rank "A" rating for 25/35 classes and "A+" for 50/60/71 classes.

## Silent Operation

Quiet, relaxing space is within reach. Operational noise is a low 22dB (25/35 classes). Operation is so silent you might even forget the air conditioner is on.

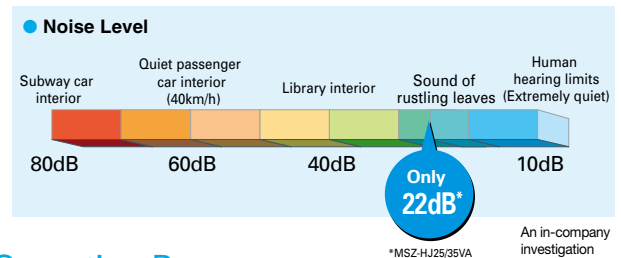

## Long Piping Length

Compared to previous models, the piping length is significantly increased, further enhancing the ease and flexibility of installation.

	MSZ-HJ60/71	MSZ-HJ25/35/50	MSZ-HC
Max piping length	30m	20m	10m
Max piping height difference	15m	12m	5m

## Operating Range

As a result of an extended operating range in cooling, these models accommodate a wider range of usage environments and applications than previous models.

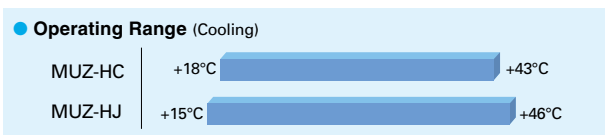

## Compact Units

The widths of both indoor and outdoor units are compact, making installation in smaller, tighter spaces possible.

Indoor Unit: MSZ-HJ25/35/50VA



Only 799mm width

Outdoor Unit: MUZ-HJ25/35VA



Only 699mm width

Compared to other models, width is down by 16%.

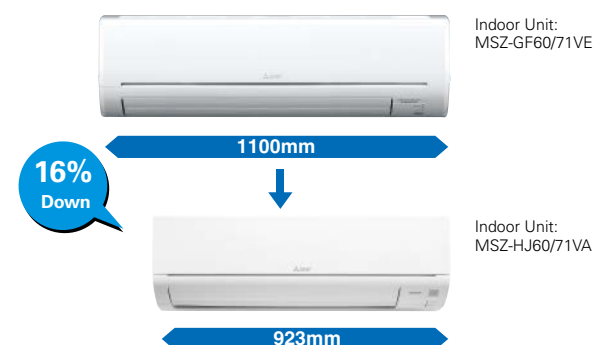



# MSZ-H SERIES



## Indoor Unit

R410A



MSZ-HJ25/35/50VA



MSZ-HJ60/71VA

## Outdoor Unit

R410A



MUZ-HJ25/35VA



MUZ-HJ50VA



MUZ-HJ60/71VA

## Remote Controller



Type	Inverter Heat Pump							
Indoor Unit	MSZ-HJ25VA		MSZ-HJ35VA	MSZ-HJ50VA	MSZ-HJ60VA	MSZ-HJ71VA		
Outdoor Unit	MUZ-HJ25VA		MUZ-HJ35VA	MUZ-HJ50VA	MUZ-HJ60VA	MUZ-HJ71VA		
Refrigerant	R410A <sup>(1)</sup>							
Power Source	Indoor Power supply							
Supply	Outdoor (V / Phase / Hz)							
	Design load	kW	2.5	3.1	5.0	6.1		
Cooling	Annual electricity consumption <sup>(2)</sup>	kWh/a	171	212	292	354		
	SEER <sup>(4)</sup>		5.1	5.1	6.0	6.0		
	Energy efficiency class		A	A	A+	A+		
	Capacity	Rated	kW	2.5	3.15	5.0	6.1	
		Min-Max	kW	1.3 - 3.0	1.4 - 3.5	1.3 - 5.0	1.7 - 7.1	
	Total Input	Rated	kW	0.730	1.040	2.050	1.900	
Heating (Average Season) <sup>(3)</sup>	Design load	kW	1.9 (-10°C)	2.4 (-10°C)	3.8 (-10°C)	4.6 (-10°C)	5.4 (-10°C)	
	Declared Capacity	at reference design temperature	kW	1.9 (-10°C)	2.4 (-10°C)	3.8 (-10°C)	4.6 (-10°C)	5.4 (-10°C)
		at bivalent temperature	kW	1.9 (-10°C)	2.4 (-10°C)	3.8 (-10°C)	4.6 (-10°C)	5.4 (-10°C)
		at operation limit temperature	kW	1.9 (-10°C)	2.4 (-10°C)	3.8 (-10°C)	4.6 (-10°C)	5.4 (-10°C)
	Back up heating capacity	kW	0.0 (-10°C)	0.0 (-10°C)	0.0 (-10°C)	0.0 (-10°C)	0.0 (-10°C)	
	Annual electricity consumption <sup>(2)</sup>	kWh/a	698	885	1267	1544	1854	
	SCOP <sup>(4)</sup>		3.8	3.8	4.2	4.1	4.0	
	Energy efficiency class		A	A	A+	A+	A+	
	Capacity	Rated	kW	3.15	3.6	5.4	6.8	
		Min-Max	kW	0.9 - 3.5	1.1 - 4.1	1.4 - 6.5	1.5 - 8.4	
	Total Input	Rated	kW	0.870	0.995	1.480	1.970	
Operating Current (Max)	Input	Rated	A	5.8	6.5	9.8	12.5	
	Operating Current(Max)		A	0.020	0.024	0.037	0.055	
Indoor Unit	Dimensions	H*W*D	mm	290-799-232	290-799-232	290-799-232	305-923-250	
	Weight		kg	9	9	9	13	
	Air Volume (SLo-Lo-Mid-Hi-SHi <sup>(5)</sup> (Dry/Wet))	Cooling	m <sup>3</sup> /min	3.8 - 5.5 - 7.3 - 9.5	3.8 - 5.7 - 7.8 - 10.9	6.3 - 9.1 - 11.1 - 12.9	9.3 - 12.2 - 15.0 - 19.9	10.0 - 12.2 - 15.0 - 19.9
		Heating	m <sup>3</sup> /min	3.5 - 5.5 - 7.5 - 10.0	3.5 - 5.5 - 7.5 - 10.3	6.1 - 8.3 - 11.1 - 14.3	9.4 - 12.5 - 16.0 - 19.9	10.3 - 12.7 - 16.4 - 19.9
	Sound Level (SPL) (SLo-Lo-Mid-Hi-SHi <sup>(5)</sup> )	Cooling	dB(A)	22 - 30 - 37 - 43	22 - 31 - 38 - 45	28 - 36 - 40 - 45	31 - 38 - 44 - 50	33 - 38 - 44 - 50
		Heating	dB(A)	23 - 30 - 37 - 43	23 - 30 - 37 - 44	27 - 34 - 41 - 47	31 - 38 - 44 - 49	33 - 38 - 44 - 49
	Sound Level (PWL)	Cooling	dB(A)	57	60	60	65	65
		Heating	dB(A)	57	60	60	65	65
	Dimensions	H*W*D	mm	538-699-249	538-699-249	550-800-285	880-840-330	
	Weight		kg	24	25	36	55	
Outdoor Unit	Air Volume	Cooling	m <sup>3</sup> /min	31.5	31.5	36.3	47.9	
		Heating	m <sup>3</sup> /min	31.5	31.5	34.8	47.9	
	Sound Level (SPL)	Cooling	dB(A)	50	50	50	55	
		Heating	dB(A)	50	50	51	55	
	Sound Level (PWL)	Cooling	dB(A)	63	64	64	66	
		Heating	dB(A)	63	64	64	66	
Operating Current (Max)		A	5.5	6.2	9.4	12.0		
Breaker Size		A	10	10	12	16		
Ext. Piping	Diameter	Liquid/Gas	mm	6.35/9.52	6.35/9.52	6.35/12.7	6.35/15.88	
	Max.Length	Out-In	m	20	20	20	30	
	Max.Height	Out-In	m	12	12	12	15	
Guaranteed Operating Range (Outdoor)	Cooling	°C	+15 ~ +46	+15 ~ +46	+15 ~ +46	+15 ~ +46	+15 ~ +46	
	Heating	°C	-10 ~ +24	-10 ~ +24	-10 ~ +24	-10 ~ +24	-10 ~ +24	

<sup>(1)</sup> Refrigerant leakage contributes to climate change. Refrigerant with lower global warming potential (GWP) would contribute less to global warming than a refrigerant with higher GWP, if leaked to the atmosphere. This appliance contains a refrigerant fluid with a GWP equal to 1975. This means that if 1 kg of this refrigerant fluid would be leaked to the atmosphere, the impact on global warming would be 1975 times higher than 1 kg of CO<sub>2</sub> over a period of 100 years. Never try to interfere with the refrigerant circuit yourself or disassemble the product yourself and always ask a professional.

The GWP of R410A is 2088 in the IPCC 4th Assessment Report.

<sup>(2)</sup> Energy consumption based on standard test results. Actual energy consumption will depend on how the appliance is used and where it is located.

<sup>(3)</sup> SHi: Super High

<sup>(4)</sup> SEER, SCOP and other related description are based on COMMISSION DELEGATED REGULATION (EU) No.626/2011. The temperature conditions for calculating SCOP are based on "Average Season".

<sup>(5)</sup> Please see page 51-52 for heating (warmer season) specifications.

# MFZ SERIES

High Capacity, Energy Savings and a Design in Harmony with Living Spaces  
Raise the Value of Your Room to the Next Level.

MFZ-KT25/35/50/60VG

R32



## Simple, Flat Design

Uneven surfaces have been smoothed to provide a simple design with linear beauty, harmonised with all types of interiors.

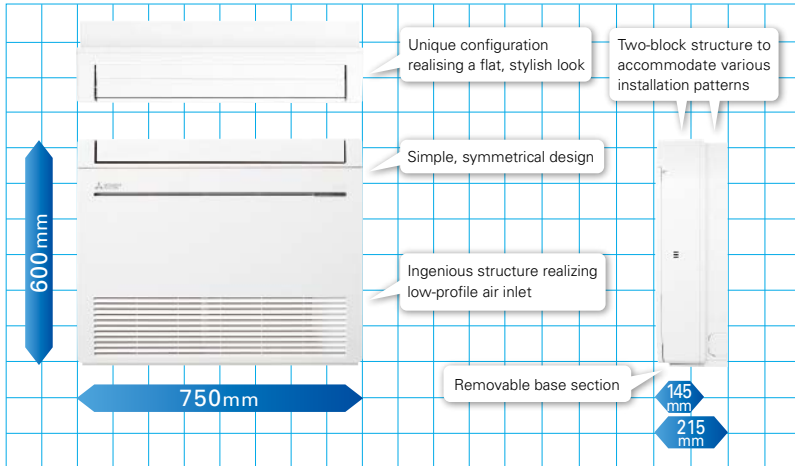

### Images of installed unit



## New Line-up

New models have been introduced to expand the line-up. The diverse selection enables the best solution for both customers and locations.

Capacity	2.5kW	3.5kW	5.0kW	6.0kW
MFZ-KJ	✓	✓	✓	
		↓		
MFZ-KT	✓	✓	✓	✓

## Multi-flow Vane

Three uniquely shaped vanes control the airflow and allow the freedom to customize comfort according to preferences.

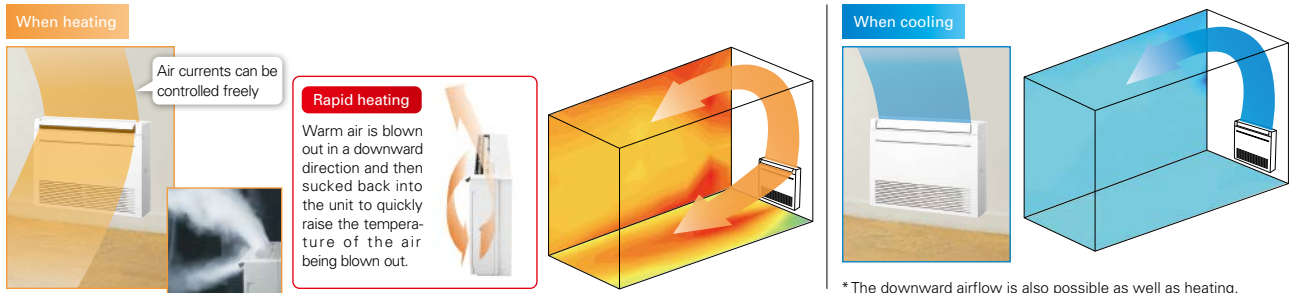

## Weekly Timer (Introduced in response to market demand)

Temperature settings and On/Off control can be managed over a period of one week using the Weekly Timer. Up to eight setting patterns per calendar day are possible.

## Quiet Operation

The indoor unit noise level is as low as 19dB for MFZ Series, offering a peaceful inside environment.

\* Single connection only.

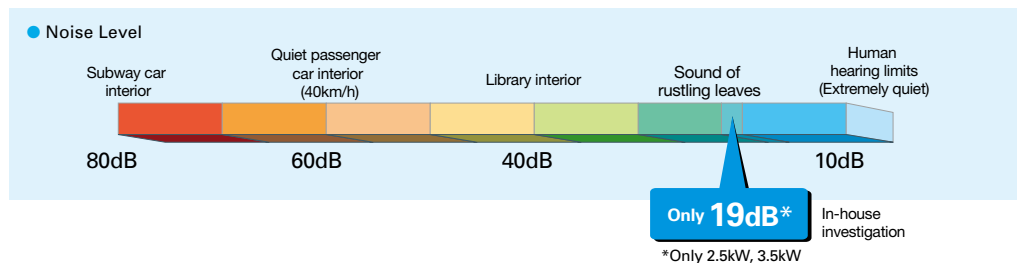

# MFZ-KT SERIES



## Indoor Unit

R32



MFZ-KT25/35/50/60VG

## Outdoor Unit

R32



SUZ-M25/35VA



SUZ-M50VA



SUZ-M60VA

## Remote Controller



Enclosed in MFZ-KT



\*optional



\*optional



\*optional



Type		Inverter Heat Pump					
Indoor Unit		MFZ-KT25VG	MFZ-KT35VG	MFZ-KT50VG	MFZ-KT60VG		
Outdoor Unit		SUZ-M25VA	SUZ-M35VA	SUZ-M50VA	SUZ-M60VA		
Refrigerant		R32 <sup>(*)</sup>	R32 <sup>(*)</sup>	R32 <sup>(*)</sup>	R32 <sup>(*)</sup>		
Power Supply		Outdoor power supply 230 / Single / 50					
Cooling	Design load	kW	2.5	3.5	5.0	6.1	
	Annual electricity consumption <sup>(2)</sup>	kWh/a	134	185	257	343	
	SEER <sup>(4)</sup>		6.5	6.6	6.8	6.2	
	Capacity	Energy efficiency class		A <sup>++</sup>	A <sup>++</sup>	A <sup>++</sup>	A <sup>++</sup>
		Rated	kW	2.5	3.5	5.0	6.1
Total Input	Min-Max	kW	1.6 - 3.2	0.9 - 3.9	1.2 - 5.6	1.7 - 6.3	
	Rated	kW	0.62	1.06	1.55	1.84	
Heating (Average Season)	Design load	kW	2.2	2.6	4.3	4.6	
	Declared Capacity	at reference design temperature	kW	2.0 (-10°C)	2.3 (-10°C)	3.5 (-10°C)	4.1 (-10°C)
		at bivalent temperature	kW	2.0 (-7°C)	2.3 (-7°C)	3.9 (-7°C)	4.1 (-7°C)
		at operation limit temperature	kW	2.0 (-10°C)	2.3 (-10°C)	3.5 (-10°C)	4.1 (-10°C)
	Back up heating capacity	kW	0.2	0.3	0.8	0.5	
	Annual electricity consumption <sup>(2)</sup>	kWh/a	732	825	1423	1568	
	SCOP <sup>(4)</sup>		4.2	4.4	4.2	4.1	
	Capacity	Energy efficiency class		A <sup>+</sup>	A <sup>+</sup>	A <sup>+</sup>	A <sup>+</sup>
Rated		kW	3.4	4.3	6.0	7.0	
Total Input	Min-Max	kW	1.3 - 4.2	1.1 - 5.0	1.5 - 7.2	1.6 - 8.0	
	Rated	kW	0.91	1.26	1.86	2.18	
Operating Current (Max)							
Indoor Unit	Input	Rated	kW	0.020 / 0.024	0.020 / 0.024	0.037 / 0.052	0.063 / 0.059
	Operating Current(Max)		A	0.20	0.20	0.45	0.55
	Dimensions	H*W*D	mm	600-750-215	600-750-215	600-750-215	600-750-215
	Weight		kg	14.5	14.5	14.5	15.0
	Air Volume (SLO-Lo-Mid-Hi-SHI <sup>(3)</sup> )	Cooling	m <sup>3</sup> /min	3.9 - 4.8 - 6.5 - 7.8 - 8.9	3.9 - 4.8 - 6.5 - 7.8 - 8.9	5.6 - 6.7 - 8.6 - 10.4 - 12.3	5.6 - 8.0 - 9.6 - 12.3 - 15.0
		Heating	m <sup>3</sup> /min	3.5 - 4.0 - 5.6 - 7.3 - 9.7	3.5 - 4.0 - 5.6 - 7.3 - 9.7	6.0 - 7.7 - 9.4 - 11.6 - 14.0	6.0 - 7.7 - 9.7 - 12.5 - 14.6
	Sound Level (SPL) (SLO-Lo-Mid-Hi-SHI <sup>(3)</sup> )	Cooling	dB(A)	19 - 24 - 31 - 37 - 41	19 - 24 - 31 - 37 - 41	28 - 32 - 37 - 42 - 48	28 - 36 - 40 - 46 - 53
		Heating	dB(A)	19 - 23 - 30 - 37 - 44	19 - 23 - 30 - 37 - 44	29 - 35 - 40 - 44 - 49	29 - 35 - 41 - 47 - 51
	Sound Level (PWL)	Cooling	dB(A)	54	54	60	65
	Outdoor Unit	Dimensions	H*W*D	mm	550-800-285	550-800-285	714-800-285
Weight			kg	30	35	41	54
Air Volume		Cooling	m <sup>3</sup> /min	36.3	34.3	45.8	50.1
		Heating	m <sup>3</sup> /min	34.6	32.7	43.7	50.1
Sound Level (SPL)		Cooling	dB(A)	45	48	48	49
		Heating	dB(A)	46	48	49	51
Sound Level (PWL)		Cooling	dB(A)	59	59	64	65
Operating Current(Max)			A	7	9	14	15
Breaker Size			A	10	10	16	16
Ext. Piping		Diameter	Liquid/Gas	mm	6.35 / 9.52	6.35 / 9.52	6.35 / 12.7
	Max.Length	Out-In	m	20	20	30	30
	Max.Height	Out-In	m	12	12	30	30
Guaranteed Operating Range [Outdoor]	Cooling	°C	-10 ~ +46	-10 ~ +46	-15 ~ +46	-15 ~ +46	
	Heating	°C	-10 ~ +24	-10 ~ +24	-10 ~ +24	-10 ~ +24	

(\*) Refrigerant leakage contributes to climate change. Refrigerant with lower global warming potential (GWP) would contribute less to global warming than a refrigerant with higher GWP, if leaked to the atmosphere. This appliance contains a refrigerant fluid with a GWP equal to 1975. This means that if 1 kg of this refrigerant fluid would be leaked to the atmosphere, the impact on global warming would be 1975 times higher than 1 kg of CO<sub>2</sub>, over a period of 100 years. Never try to interfere with the refrigerant circuit yourself or disassemble the product yourself and always ask a professional.  
The GWP of R410A is 2088 in the IPCC 4th Assessment Report.

(2) Energy consumption based on standard test results. Actual energy consumption will depend on how the appliance is used and where it is located.

(3) SHI: Super High

(4) SEER, SCOP and other related description are based on COMMISSION DELEGATED REGULATION (EU) No 626/2011. The temperature conditions for calculating SCOP are based on "Average Season".

# MLZ SERIES

Introducing a new type of ceiling cassette for the Multi-Split Series with streamlined interior dimensions and a sharp, sleek appearance.

R32  
R410A  
Multi

MLZ-KP25/35/50VF



GOOD DESIGN



reddot award 2018 winner



## Slim Design

Industry leading slim body realized a simple design with linear beauty.

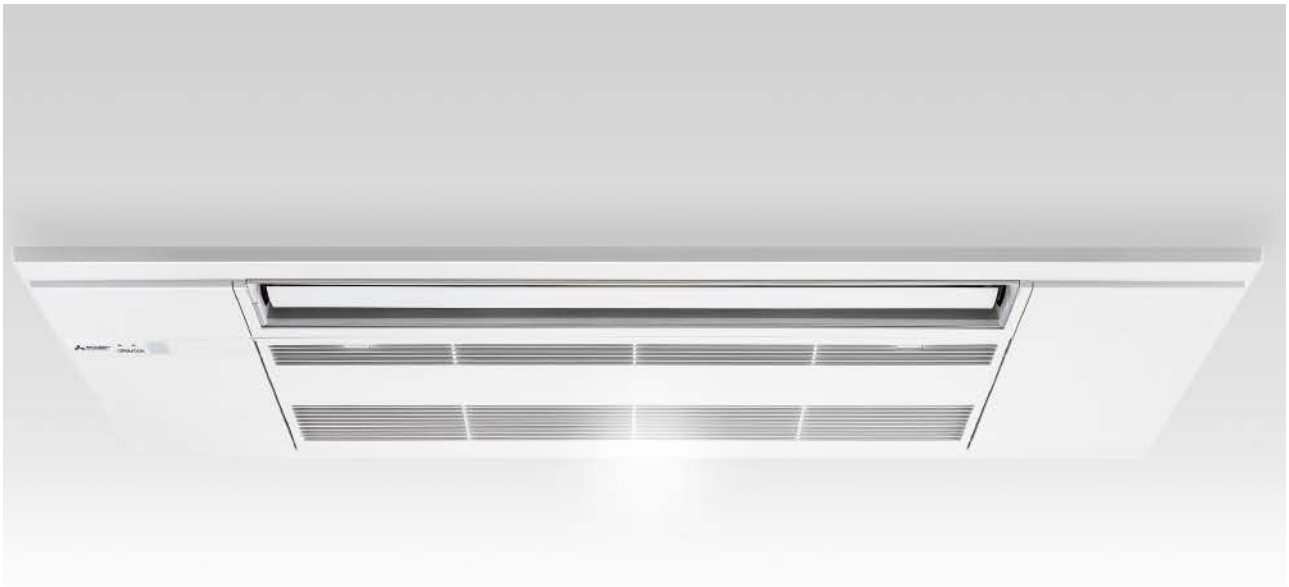

## Ceiling Mounted

Installing the ceiling-mounted MLZ Series unit in a room creates a more spacious feel that enhances room comfort. This overhead format is also an excellent solution when lighting equipment is installed at the centre of the room and fixtures such as book shelves are mounted on wall surfaces.

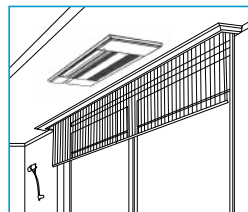

## Slim Body

The new units are designed with a slim body (only 185mm high), ensuring easy installation even when low ceiling cavities limit installation space. The need for ceiling cavity service space is also eliminated, further reducing the dimensions required for installation.



## Set Airflow According to Ceiling Height

Dual-level airflow selection is engineered to accommodate specific ceiling heights. This is a key feature for adjusting airflow effectively when it is either too strong or too weak due to being mismatched with the height of the ceiling.

	25	35	50
Standard	2.4m	2.4m	2.4m
High ceiling	2.7m	2.7m	2.7m

## Auto Vane Control

Outlet vanes can be moved left and right, and up and down using the remote controller. This improved airflow control feature solves the problem of drafts.

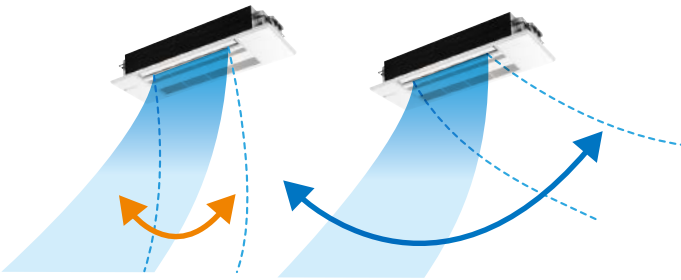

**Up and Down**

**Left and Right**

\*Only available when Econo Cool is set.

## Horizontal Airflow

The new airflow control completely eliminates that uncomfortable drafty-feeling with the introduction of a horizontal airflow that spreads across the ceiling. The ideal airflow for offices and restaurants.

[Horizontal Airflow]  
Model name: MLZ-KP35VF  
Ceiling height: 2.4m  
Model: Cooling

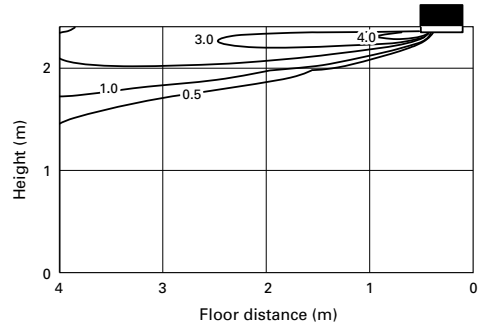

## Weekly Timer Built-in Weekly Timer Function

Easily set desired temperatures and operation ON/OFF times to match lifestyle patterns. Reduce wasted energy consumption by using the timer to prevent forgetting to turn off the unit and eliminate temperature setting adjustments.

### Example Operation Pattern (Winter/Heating mode)

	Mon.	Tues.	Wed.	Thurs.	Fri.	Sat.	Sun.
6:00	ON 20°C	ON 20°C	ON 20°C	ON 20°C	ON 20°C	ON 20°C	ON 20°C
8:00	Automatically changes to high-power operation at wake-up time						
10:00	OFF	OFF	OFF	OFF	OFF	ON 18°C	ON 18°C
12:00	Automatically turned off during work hours					Midday is warmer, so the temperature is set lower	
14:00							
16:00							
18:00	ON 22°C	ON 22°C	ON 22°C	ON 22°C	ON 22°C	ON 22°C	ON 22°C
20:00	Automatically turns on, synchronized with arrival at home					Automatically raises temperature setting to match time when outside-air temperature is low	
22:00							
(during sleeping hours)	ON 18°C	ON 18°C	ON 18°C	ON 18°C	ON 18°C	ON 10°C	ON 10°C
	Automatically lowers temperature at bedtime for energy-saving operation at night						

### Settings

**Pattern Settings:** Input up to four settings for each day

**Settings:** •Start/Stop operation •Temperature setting \*The operation mode cannot be set.

### Easy set-up using dedicated buttons



The remote controller is equipped with buttons that are used exclusively for setting the Weekly Timer. Setting operation patterns is easy and quick.

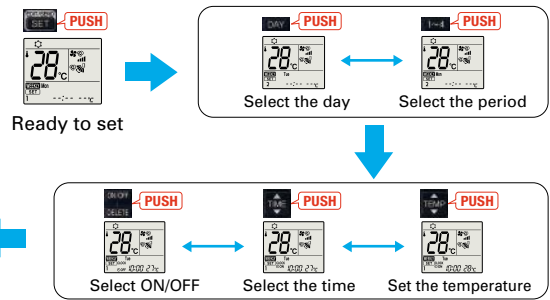

- Start by pushing the "SET" button and follow the instructions to set the desired patterns. Once all of the desired patterns are input, point the top end of the remote controller at the indoor unit and push the "SET" button one more time. (Push the "SET" button only after inputting all of the desired patterns into the remote controller memory. Pushing the "CANCEL" button will end the set-up process without sending the operation patterns to the indoor unit).
- It takes a few seconds to transmit the Weekly Timer operation patterns to the indoor unit. Please continue to point the remote controller at the indoor unit until all data has been sent.



# Easy Installation

## Industry leading Slim Body

Inovative size which enables to fold the refrigerant piping above the unit.

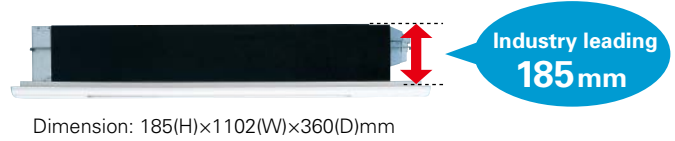

## Temporary hanging hook

Work efficiency has improved during installation.

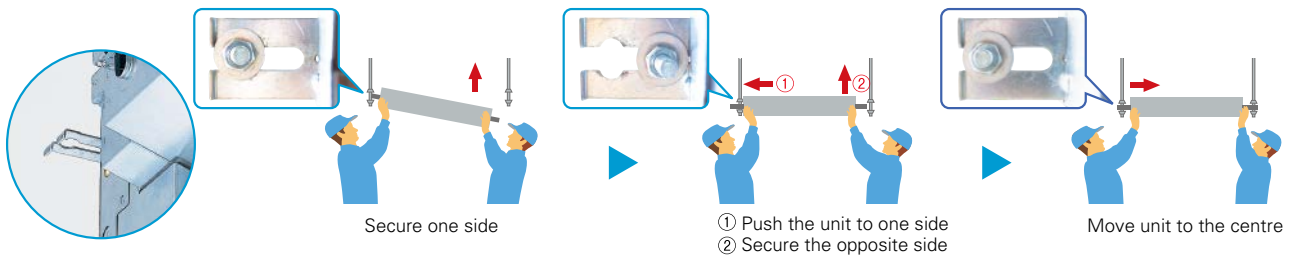

## Drain Piping Supporters + Drain Cover

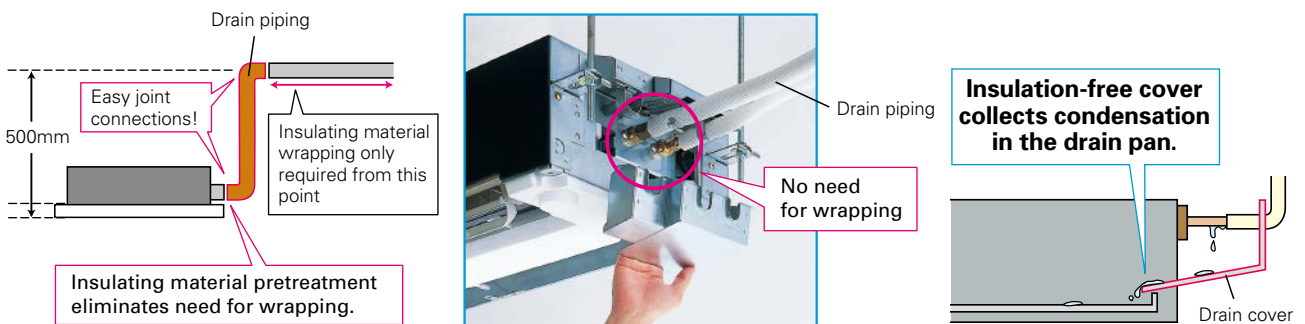

## Wi-Fi Interface Installation (Optional)

The indoor unit panel is equipped with a Wi-Fi Interface pocket, contributing to the beautiful appearance, easy installation, and maintenance.

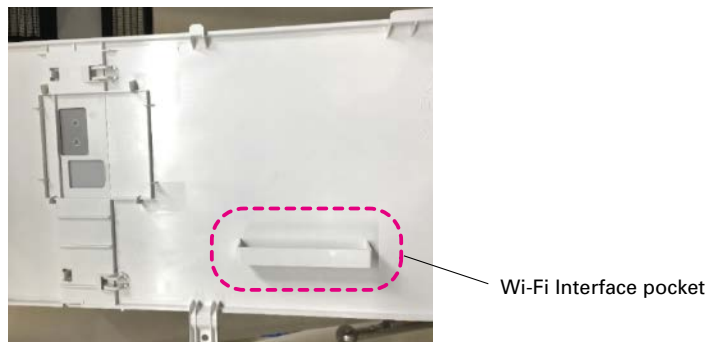

# MLZ-KP SERIES



## Indoor Unit



MLZ-KP25/35/50VF



## Panel

MLP-444W

## Outdoor Unit



SUZ-M25/35VA



SUZ-M50VA

## Remote Controller



Enclosed in MLZ-KP



\*optional



\*optional



\*optional



Type	Inverter Heat Pump					
Indoor Unit	MLZ-KP25VF		MLZ-KP35VF	MLZ-KP50VF		
Outdoor Unit	SUZ-M25VA		SUZ-M35VA	SUZ-M50VA		
Refrigerant	R32 <sup>(1)</sup>					
Power Source	Outdoor Power supply					
Supply	Outdoor (V / Phase / Hz)					
Cooling	Design load	kW	2.5	3.5	5.0	
	Annual electricity consumption <sup>(2)</sup>	kWh/a	141	175	260	
	SEER <sup>(3)</sup>		6.2	7.0	6.7	
	Capacity	Energy efficiency class		A++	A++	A++
		Rated	kW	2.5	3.5	5.0
Total Input	Min-Max	kW	1.4 - 3.2	0.8 - 3.9	1.7 - 5.6	
	Rated	kW	0.59	0.94	1.38	
Heating (Average Season)	Design load	kW	2.2	2.6	4.3	
	Declared Capacity	at reference design temperature	kW	2.0 (-10°C)	2.3 (-10°C)	3.8 (-10°C)
		at bivalent temperature	kW	2.0 (-7°C)	2.3 (-7°C)	3.8 (-7°C)
		at operation limit temperature	kW	2.0 (-10°C)	2.3 (-10°C)	3.8 (-10°C)
	Back up heating capacity	kW	0.2	0.3	0.5	
Annual electricity consumption <sup>(2)</sup>	kWh/a	697	791	1397		
Operating Current (Max)	SCOP <sup>(4)</sup>		4.4	4.6	4.3	
	Energy efficiency class		A+	A++	A+	
	Rated	kW	3.2	4.1	6.0	
Indoor Unit	Capacity	Min-Max	kW	1.4 - 4.2	1.1 - 4.9	1.7 - 7.2
		Rated	kW	0.80	1.10	1.86
	Input	Rated	A	7.2	8.9	13.9
		Rated	kW	0.04	0.04	0.04
	Operating Current(Max)	A	0.40	0.40	0.40	
	Dimensions	H*W*D	mm	185-1102-360	185-1102-360	185-1102-360
	Weight		kg	15.5	15.5	15.5
	Air Volume (SLo-Lo-Mid-Hi <sup>(5)</sup> (Dry/Wet))	Cooling	m <sup>3</sup> /min	6.0-7.2-8.0-8.8	6.0-7.3-8.4-9.4	6.0-8.3-9.8-11.4
			Heating	6.0-7.0-8.2-9.2	6.0-7.7-8.8-9.9	6.0-8.8-10.3-11.8
		Sound Level (SPL) (SLo-Lo-Mid-Hi <sup>(5)</sup> )	Cooling	dB(A)	27-31-34-38	27-32-36-40
Heating			dB(A)	26-27-34-37	29-32-36-40	26-37-42-48
Sound Level (PWL)	Cooling	dB(A)	52	53	59	
Dimensions	H*W*D	mm	24-1200-424	24-1200-424	24-1200-424	
Weight		kg	3.5	3.5	3.5	
Outdoor Unit	Dimensions	H*W*D	mm	550-800-285	550-800-285	550-800-285
	Weight		kg	30	35	41
	Air Volume	Cooling	m <sup>3</sup> /min	36.3	34.3	45.8
		Heating	m <sup>3</sup> /min	34.6	32.7	43.7
	Sound Level (SPL)	Cooling	dB(A)	45	48	48
		Heating	dB(A)	46	48	49
	Sound Level (PWL)	Cooling	dB(A)	59	59	64
	Operating Current (Max)	A	6.8	8.5	13.5	
	Breaker Size	A	10	10	20	
	Ext. Piping	Diameter	Liquid/Gas	mm	6.35/9.52	6.35/12.7
Max.Length		Out-In	m	20	30	
Max.Height		Out-In	m	12	30	
Guaranteed Operating Range (Outdoor)	Cooling	°C	-10~+46	-10~+46	-15~+46	
	Heating	°C	-10~+24	-10~+24	-10~+24	

<sup>(1)</sup> Refrigerant leakage contributes to climate change. Refrigerant with lower global warming potential (GWP) would contribute less to global warming than a refrigerant with higher GWP, if leaked to the atmosphere. This appliance contains a refrigerant fluid with a GWP equal to 1975. This means that if 1 kg of this refrigerant fluid would be leaked to the atmosphere, the impact on global warming would be 1975 times higher than 1 kg of CO<sub>2</sub>, over a period of 100 years. Never try to interfere with the refrigerant circuit yourself or disassemble the product yourself and always ask a professional.

The GWP of R410A is 2088 in the IPCC 4th Assessment Report.

<sup>(2)</sup> Energy consumption based on standard test results. Actual energy consumption will depend on how the appliance is used and where it is located.

<sup>(3)</sup> SH: Super High

<sup>(4)</sup> SEER, SCOP and other related description are based on COMMISSION DELEGATED REGULATION (EU) No.626/2011. The temperature conditions for calculating SCOP are based on "Average Season".

# Specification on Warmer/Colder Condition

Type		Inverter Heat Pump								
Indoor Unit		MSZ-LN25VG2		MSZ-LN35VG2		MSZ-LN50VG2		MSZ-LN60VG2		
Outdoor Unit		MUZ-LN25VG2	MUZ-LN25VGHZ2	MUZ-LN35VG2	MUZ-LN35VGHZ2	MUZ-LN50VG2	MUZ-LN50VGHZ	MUZ-LN60VG2		
Refrigerant		R32 <sup>(3)</sup>								
Cooling	Design load	kW	2.5	2.5	3.5	3.5	5	5.0	6.1	
	Annual electricity consumption <sup>(2)</sup>	kWh/a	83	83	129	130	205	230	285	
	SEER		10.5	10.5	9.5	9.4	8.5	7.6	7.5	
		Energy efficiency class	A+++	A+++	A+++	A+++	A+++	A++	A++	
Heating (Warmer Season)	Design load	kW	1.7 (2°C)	1.8 (2°C)	2.0 (2°C)	2.2 (2°C)	2.5 (2°C)	3.3 (2°C)	3.3 (2°C)	
	Declared Capacity	at reference design temperature	kW	1.7 (2°C)	1.8 (2°C)	2.0 (2°C)	2.2 (2°C)	2.5 (2°C)	3.3 (2°C)	3.3 (2°C)
		at bivalent temperature	kW	1.7 (2°C)	1.8 (2°C)	2.0 (2°C)	2.2 (2°C)	2.5 (2°C)	3.3 (2°C)	3.3 (2°C)
		at operation limit temperature	kW	2.5 (-15°C)	2.3 (-25°C)	3.2 (-15°C)	3.1 (-25°C)	4.2 (-15°C)	4.7 (-25°C)	6.0 (-15°C)
	Back up heating capacity	kW	0.0 (2°C)	0.0 (2°C)	0.0 (2°C)	0.0 (2°C)	0.0 (2°C)	0.0 (2°C)	0.0 (2°C)	
	Annual electricity consumption <sup>(2)</sup>	kWh/a	369	382	431	467	602	779	779	
	SCOP		6.4	6.6	6.5	6.5	5.8	5.9	5.9	
		Energy efficiency class	A+++	A+++	A+++	A+++	A+++	A+++		
Heating (Colder Season)	Design load	kW	—	4.7 (-22°C)	—	5.9 (-22°C)	—	8.8 (-22°C)	—	
	Declared Capacity	at reference design temperature	kW	—	2.6 (-22°C)	—	3.4 (-22°C)	—	5.1 (-22°C)	—
		at bivalent temperature	kW	—	3.2 (-10°C)	—	4.0 (-10°C)	—	6.0 (-10°C)	—
		at operation limit temperature	kW	—	2.3 (-25°C)	—	3.1 (-25°C)	—	4.7 (-25°C)	—
	Back up heating capacity	kW	—	2.1 (-22°C)	—	2.5 (-22°C)	—	3.7 (-22°C)	—	
	Annual electricity consumption <sup>(2)</sup>	kWh/a	—	2425	—	3075	—	5340	—	
	SCOP		—	4.0	—	4.0	—	3.4	—	
		Energy efficiency class	—	A+	—	A+	—	A		

Type		Inverter Heat Pump												
Indoor Unit		MSZ-AP20VG		MSZ-AP25VG		MSZ-AP35VG		MSZ-AP42VG		MSZ-AP50VG		MSZ-AP60V(G)	MSZ-AP71V(G)	
Outdoor Unit		MUZ-AP20VG	MUZ-AP25VG	MUZ-AP35VG	MUZ-AP35VGH	MUZ-AP42VG	MUZ-AP42VGH	MUZ-AP50VG	MUZ-AP50VGH	MUZ-AP60VG	MUZ-AP71VG	MUZ-AP71VGH		
Refrigerant		R32 <sup>(3)</sup>												
Cooling	Design load	kW	2.0	2.5	2.5	3.5	3.5	4.2	4.2	5.0	5.0	6.1	7.1	
	Annual electricity consumption <sup>(2)</sup>	kWh/a	81	116	116	171	171	196	196	246	246	288	345	
	SEER		8.6	7.6	7.6	7.2	7.2	7.5	7.5	7.2	7.2	7.4	7.2	
		Energy efficiency class	A+++	A++	A++	A++	A++	A++	A++	A++	A++	A++	A++	
Heating (Warmer Season)	Design load	kW	1.3 (2°C)	1.3 (2°C)	1.3 (2°C)	1.6 (2°C)	1.6 (2°C)	2.1 (2°C)	2.1 (2°C)	2.3 (2°C)	2.3 (2°C)	2.5 (2°C)	3.7 (2°C)	
	Declared Capacity	at reference design temperature	kW	1.3 (2°C)	1.3 (2°C)	1.3 (2°C)	1.6 (2°C)	1.6 (2°C)	2.1 (2°C)	2.1 (2°C)	2.3 (2°C)	2.3 (2°C)	2.5 (2°C)	3.7 (2°C)
		at bivalent temperature	kW	1.3 (2°C)	1.3 (2°C)	1.3 (2°C)	1.6 (2°C)	1.6 (2°C)	2.1 (2°C)	2.1 (2°C)	2.3 (2°C)	2.3 (2°C)	2.5 (2°C)	3.7 (2°C)
		at operation limit temperature	kW	2.2 (-15°C)	2.0 (-15°C)	1.6 (-20°C)	2.2 (-15°C)	1.6 (-20°C)	3.4 (-15°C)	2.2 (-20°C)	3.4 (-15°C)	2.3 (-20°C)	3.7 (-15°C)	5.4 (-15°C)
	Back up heating capacity	kW	0.0 (2°C)	0.0 (2°C)	0.0 (2°C)	0.0 (2°C)	0.0 (2°C)	0.0 (2°C)	0.0 (2°C)	0.0 (2°C)	0.0 (2°C)	0.0 (2°C)	0.0 (2°C)	
	Annual electricity consumption <sup>(2)</sup>	kWh/a	350	337	337	923 / 418	417	507	507	563	563	627	891	
	SCOP		5.2	5.4	5.4	5.4	5.4	5.8	5.8	5.7	5.7	5.5	5.8	
		Energy efficiency class	A+++	A+++	A+++	A+++	A+++	A+++	A+++	A+++	A+++	A+++		

Type		Inverter Heat Pump						
Indoor Unit		MSZ-FH25VE2		MSZ-FH35VE2		MSZ-FH50VE2		
Outdoor Unit		MUZ-FH25VE	MUZ-FH25VEHZ	MUZ-FH35VE	MUZ-FH35VEHZ	MUZ-FH50VE	MUZ-FH50VEHZ	
Refrigerant		R410A <sup>(1)</sup>						
Cooling	Design load	kW	2.5	2.5	3.5	3.5	5.0	
	Annual electricity consumption <sup>(2)</sup>	kWh/a	96	96	138	138	244	
	SEER		9.1	9.1	8.9	8.9	7.2	
		Energy efficiency class	A+++	A+++	A+++	A+++	A++	
Heating (Warmer Season)	Design load	kW	1.7 (2°C)	1.8 (2°C)	2.0 (2°C)	2.2 (2°C)	3.3 (2°C)	
	Declared Capacity	at reference design temperature	kW	1.7 (2°C)	1.8 (2°C)	2.0 (2°C)	2.2 (2°C)	3.3 (2°C)
		at bivalent temperature	kW	1.7 (2°C)	1.8 (2°C)	2.0 (2°C)	2.2 (2°C)	3.3 (2°C)
		at operation limit temperature	kW	2.5 (-15°C)	1.7 (-25°C)	3.2 (-15°C)	2.6 (-25°C)	5.2 (-15°C)
	Back up heating capacity	kW	0.0 (2°C)	0.0 (2°C)	0.0 (2°C)	0.0 (2°C)	0.0 (2°C)	
	Annual electricity consumption <sup>(2)</sup>	kWh/a	376	397	429	471	614	
	SCOP		6.3	6.3	6.5	4.8 / 6.5	5.7	
		Energy efficiency class	A+++	A+++	A+++	A+++	A+++	

Type		Inverter Heat Pump						
Indoor Unit		MSZ-EF25VG		MSZ-EF35VG		MSZ-EF42VG		
Outdoor Unit		MUZ-EF25VG	MUZ-EF25VGH	MUZ-EF35VG	MUZ-EF35VGH	MUZ-EF42VG	MUZ-EF50VG	
Refrigerant		R32 <sup>(3)</sup>						
Cooling	Design load	kW	2.5	2.5	3.5	3.5	4.2	
	Annual electricity consumption <sup>(2)</sup>	kWh/a	96	96	139	139	186	
	SEER		9.1	9.1	8.8	8.8	7.9	
		Energy efficiency class	A+++	A+++	A+++	A+++	A++	
Heating (Warmer Season)	Design load	kW	1.3 (2°C)	1.3 (2°C)	1.6 (2°C)	1.6 (2°C)	2.1 (2°C)	
	Declared Capacity	at reference design temperature	kW	1.3 (2°C)	1.3 (2°C)	1.6 (2°C)	1.6 (2°C)	2.1 (2°C)
		at bivalent temperature	kW	1.3 (2°C)	1.3 (2°C)	1.6 (2°C)	1.6 (2°C)	2.1 (2°C)
		at operation limit temperature	kW	2.0 (-15°C)	2.0 (-15°C)	2.4 (-15°C)	2.4 (-15°C)	3.4 (-15°C)
	Back up heating capacity	kW	0.0 (2°C)	0.0 (2°C)	0.0 (2°C)	0.0 (2°C)	0.0 (2°C)	
	Annual electricity consumption <sup>(2)</sup>	kWh/a	311	311	398	398	489	
	SCOP		5.9	5.9	5.6	5.6	6.0	
		Energy efficiency class	A+++	A+++	A+++	A+++	A+++	

Type		Inverter Heat Pump							
Indoor Unit		MSZ-SF25VE3		MSZ-SF35VE3		MSZ-SF42VE3		MSZ-SF50VE3	
Outdoor Unit		MUZ-SF25VE	MUZ-SF25VEH	MUZ-SF35VE	MUZ-SF35VEH	MUZ-SF42VE	MUZ-SF42VEH	MUZ-SF50VE	MUZ-SF50VEH
Refrigerant		R410A <sup>(1)</sup>							
Cooling	Design load	kW	2.5	2.5	3.5	3.5	4.2	4.2	5.0
	Annual electricity consumption <sup>(2)</sup>	kWh/a	116	116	171	171	196	196	246
	SEER		7.6	7.6	7.2	7.2	7.5	7.5	7.2
		Energy efficiency class	A++	A++	A++	A++	A++	A++	A++
Heating (Warmer Season)	Design load	kW	1.3 (2°C)	1.3 (2°C)	1.6 (2°C)	1.6 (2°C)	2.1 (2°C)	2.1 (2°C)	2.3 (2°C)
	Declared Capacity	at reference design temperature	kW	1.3 (2°C)	1.3 (2°C)	1.6 (2°C)	1.6 (2°C)	2.1 (2°C)	2.1 (2°C)
		at bivalent temperature	kW	1.3 (2°C)	1.3 (2°C)	1.6 (2°C)	1.6 (2°C)	2.1 (2°C)	2.1 (2°C)
		at operation limit temperature	kW	2.0 (-15°C)	1.6 (-20°C)	2.2 (-15°C)	1.6 (-20°C)	3.4 (-15°C)	2.2 (-20°C)
	Back up heating capacity	kW	0.0 (2°C)	0.0 (2°C)	0.0 (2°C)	0.0 (2°C)	0.0 (2°C)	0.0 (2°C)	
	Annual electricity consumption <sup>(2)</sup>	kWh/a	337	337	923 / 418	417	507	507	
	SCOP		5.4	5.4	5.4	5.4	5.8	5.8	
		Energy efficiency class	A+++	A+++	A+++	A+++	A+++		

Type		Inverter Heat Pump					
Indoor Unit		MSZ-BT20VG	MSZ-BT25VG	MSZ-BT35VG	MSZ-BT50VG		
Outdoor Unit		MUZ-BT20VG	MUZ-BT25VG	MUZ-BT35VG	MUZ-BT50VG		
Refrigerant		R32 <sup>(*)</sup>					
Cooling	Design load	kW	2.0	2.5	3.5	5.0	
	Annual electricity consumption <sup>(2)</sup>	kWh/a	86	108	180	265	
	SEER		8.1	8.1	6.8	6.6	
		Energy efficiency class	A++	A++	A++	A++	
Heating (Warmer Season)	Design load	kW	0.9 (2°C)	1.1 (2°C)	1.3 (2°C)	2.1 (2°C)	
	Declared Capacity	at reference design temperature	kW	0.9 (2°C)	1.1 (2°C)	1.3 (2°C)	2.1 (2°C)
		at bivalent temperature	kW	0.9 (2°C)	1.1 (2°C)	1.3 (2°C)	2.1 (2°C)
		at operation limit temperature	kW	1.3 (-15°C)	1.7 (-15°C)	2.1 (-15°C)	3.4 (-15°C)
	Back up heating capacity	kW	0.0 (2°C)	0.0 (2°C)	0.0 (2°C)	0.0 (2°C)	
	Annual electricity consumption <sup>(2)</sup>	kWh/a	234	268	304	543	
SCOP <sup>(4)</sup>		5.3	5.7	5.9	5.4		
		Energy efficiency class	A+++	A+++	A+++	A+++	

Type		Inverter Heat Pump					
Indoor Unit		MSZ-GF60VE2	MSZ-GF71VE2	MSZ-WN25VA	MSZ-WN35VA		
Outdoor Unit		MUZ-GF60VE	MUZ-GF71VE	MUZ-WN25VA	MUZ-WN35VA		
Refrigerant		R410A <sup>(*)</sup>					
Cooling	Design load	kW	6.1	7.1	2.5	3.1	
	Annual electricity consumption <sup>(2)</sup>	kWh/a	311	364	141	173	
	SEER		6.8	6.8	6.2	6.2	
		Energy efficiency class	A++	A++	A++	A++	
Heating (Warmer Season)	Design load	kW	2.5 (2°C)	3.7 (2°C)	1.1 (2°C)	1.3 (2°C)	
	Declared Capacity	at reference design temperature	kW	2.5 (2°C)	3.7 (2°C)	1.1 (2°C)	1.3 (2°C)
		at bivalent temperature	kW	2.5 (2°C)	3.7 (2°C)	1.1 (2°C)	1.3 (2°C)
		at operation limit temperature	kW	3.7 (-15°C)	5.4 (-15°C)	1.6 (-15°C)	2.0 (-15°C)
	Back up heating capacity	kW	0.0 (2°C)	0.0 (2°C)	0.0 (2°C)	0.0 (2°C)	
	Annual electricity consumption <sup>(2)</sup>	kWh/a	664	963	304	362	
SCOP <sup>(4)</sup>		5.3	5.4	5.0	5.0		
		Energy efficiency class	A+++	A+++	A++	A++	

Type		Inverter Heat Pump								
Indoor Unit		MSZ-HJ25VA	MSZ-HJ35VA	MSZ-HJ50VA	MSZ-HJ60VA	MSZ-HJ71VA	MSZ-DM25VA	MSZ-DM35VA		
Outdoor Unit		MUZ-HJ25VA	MUZ-HJ35VA	MUZ-HJ50VA	MUZ-HJ60VA	MUZ-HJ71VA	MUZ-DM25VA	MUZ-DM35VA		
Refrigerant		R410A <sup>(*)</sup>								
Cooling	Design load	kW	2.5	3.1	5.0	6.1	7.1	2.5	3.1	
	Annual electricity consumption <sup>(2)</sup>	kWh/a	171	212	292	354	441	149	190	
	SEER		5.1	5.1	6.0	6.0	5.6	5.8	5.7	
		Energy efficiency class	A	A	A+	A+	A+	A+	A+	
Heating (Warmer Season)	Design load	kW	1.1 (2°C)	1.3 (2°C)	2.1 (2°C)	2.5 (2°C)	2.9 (2°C)	1.1 (2°C)	1.3 (2°C)	
	Declared Capacity	at reference design temperature	kW	1.1 (2°C)	1.3 (2°C)	2.1 (2°C)	2.5 (2°C)	2.9 (2°C)	1.1 (2°C)	1.3 (2°C)
		at bivalent temperature	kW	1.1 (2°C)	1.3 (2°C)	2.1 (2°C)	2.5 (2°C)	2.9 (2°C)	1.1 (2°C)	1.3 (2°C)
		at operation limit temperature	kW	1.9 (-10°C)	2.4 (-10°C)	3.8 (-10°C)	4.6 (-10°C)	5.4 (-10°C)	1.9 (-10°C)	2.4 (-10°C)
	Back up heating capacity	kW	0.0 (2°C)	0.0 (2°C)	0.0 (2°C)	0.0 (2°C)	0.0 (2°C)	0.0 (2°C)	0.0 (2°C)	
	Annual electricity consumption <sup>(2)</sup>	kWh/a	356	426	539	674	813	325	386	
SCOP <sup>(4)</sup>		4.3	4.3	5.5	5.1	4.9	4.7	4.7		
		Energy efficiency class	A+	A+	A+++	A+++	A++	A++	A++	

Type		Inverter Heat Pump							
Indoor Unit		MSZ-HR25VF	MSZ-HR35VF	MSZ-HR42VF	MSZ-HR50VF	MSZ-HR60VF	MSZ-HR71VF		
Outdoor Unit		MUZ-HR25VF	MUZ-HR35VF	MUZ-HR42VF	MUZ-HR50VF	MUZ-HR60VF	MUZ-HR71VF		
Refrigerant		R32 <sup>(*)</sup>							
Cooling	Design load	kW	2.5	3.4	4.2	5.0	6.1	7.1	
	Annual electricity consumption <sup>(2)</sup>	kWh/a	141	191	226	269	296	355	
	SEER		6.2	6.2	6.5	6.5	7.2	7.0	
		Energy efficiency class	A++	A++	A++	A++	A++	A++	
Heating (Warmer Season)	Design load	kW	1.1 (2°C)	1.3 (2°C)	1.6 (2°C)	2.1 (2°C)	2.5 (2°C)	3.0 (2°C)	
	Declared Capacity	at reference design temperature	kW	1.1 (2°C)	1.3 (2°C)	1.6 (2°C)	2.1 (2°C)	2.5 (2°C)	3.0 (2°C)
		at bivalent temperature	kW	1.1 (2°C)	1.3 (2°C)	1.6 (2°C)	2.1 (2°C)	2.5 (2°C)	3.0 (2°C)
		at operation limit temperature	kW	1.9 (-10°C)	2.4 (-10°C)	2.9 (-10°C)	3.8 (-10°C)	4.6 (-10°C)	5.4 (-10°C)
	Back up heating capacity	kW	0.0 (2°C)	0.0 (2°C)	0.0 (2°C)	0.0 (2°C)	0.0 (2°C)	0.0 (2°C)	
	Annual electricity consumption <sup>(2)</sup>	kWh/a	289	344	427	558	640	802	
SCOP <sup>(4)</sup>		5.3	5.2	5.2	5.2	5.4	5.2		
		Energy efficiency class	A+++	A+++	A+++	A+++	A+++	A+++	

(\*) Refrigerant leakage contributes to climate change. Refrigerant with lower global warming potential (GWP) would contribute less to global warming than a refrigerant with higher GWP, if leaked to the atmosphere. This appliance contains a refrigerant fluid with a GWP equal to 1975. This means that if 1 kg of this refrigerant fluid would be leaked to the atmosphere, the impact on global warming would be 1975 times higher than 1 kg of CO<sub>2</sub>, over a period of 100 years. Never try to interfere with the refrigerant circuit yourself or disassemble the product yourself and always ask a professional.

(2) Energy consumption based on standard test results. Actual energy consumption will depend on how the appliance is used and where it is located.

(3) Refrigerant leakage contributes to climate change. Refrigerant with lower global warming potential (GWP) would contribute less to global warming than a refrigerant with higher GWP, if leaked to the atmosphere. This appliance contains a refrigerant fluid with a GWP equal to 550. This means that if 1 kg of this refrigerant fluid would be leaked to the atmosphere, the impact on global warming would be 550 times higher than 1 kg of CO<sub>2</sub>, over a period of 100 years. Never try to interfere with the refrigerant circuit yourself or disassemble the product yourself and always ask a professional.